

Non-wovens

Contents

- 1 Introduction
 - ◆ 1.1 Raw material
 - ◆ 1.2 Application
- 2 Sample IP analysis
 - ◆ 2.1 Year wise IP activity
 - ◆ 2.2 Competitive analysis
 - ◆ 2.3 Sample analysis of some patents
 - ◇ 2.3.1 Design patents
- 3 Pictorial analysis
 - ◆ 3.1 Absorbent pad
 - ◆ 3.2 Attaching napkin to garment
 - ◆ 3.3 Fastening means
 - ◆ 3.4 Shoulder strap pad for bra
 - ◆ 3.5 Tampon
- 4 Production patents
- 5 Non Wovens for Skin care wipes
- 6 Like this report?
 - ◆ 6.1 Contact Dolcera

Introduction

Nonwoven textiles are those which are neither woven nor knit, for example felt. General use hyphenates the word, but industrial use spells it as one word. Non-wovens are typically not strong (unless reinforced by a backing or densified). In the recent years non-woven material has become an alternative to polyurethane foam.

Non-woven fabric is typically manufactured by putting small fibers together in the form of a sheet (web) and then binding them either mechanically (as in the case of felt, by interlocking them with serrated needles such that the inter-fiber friction results in a stronger fabric), with an adhesive, or thermally (by applying binder (in the form of powder, paste, or polymer melt) and melting the binder onto the web by increasing temperature).

Raw material

Non-woven materials are nowadays mainly produced from man-made fibers. Two synthetic polymers dominate the market: polypropylene and polyesters (mainly PET). Nonwovens are often application-designated as either durable or disposable. Nonwoven used as a housewrap to prevent water infiltration is a durable nonwoven. Nonwoven used as a facing on a baby diaper is a disposable or single-use nonwoven.

Application

Sample IP analysis

- **Area:** Baby diapers and Feminine hygiene.
- **Search:** Based on title, abstract and claims for some major companies in this field.

Year wise IP activity

- Based on title, abstract and claims for some major companies in this field. The graph is based on the patents of Kimberly-Clark Corp, Johnson & Johnson, Procter & Gamble, and Playtex from 1836 to 2006.

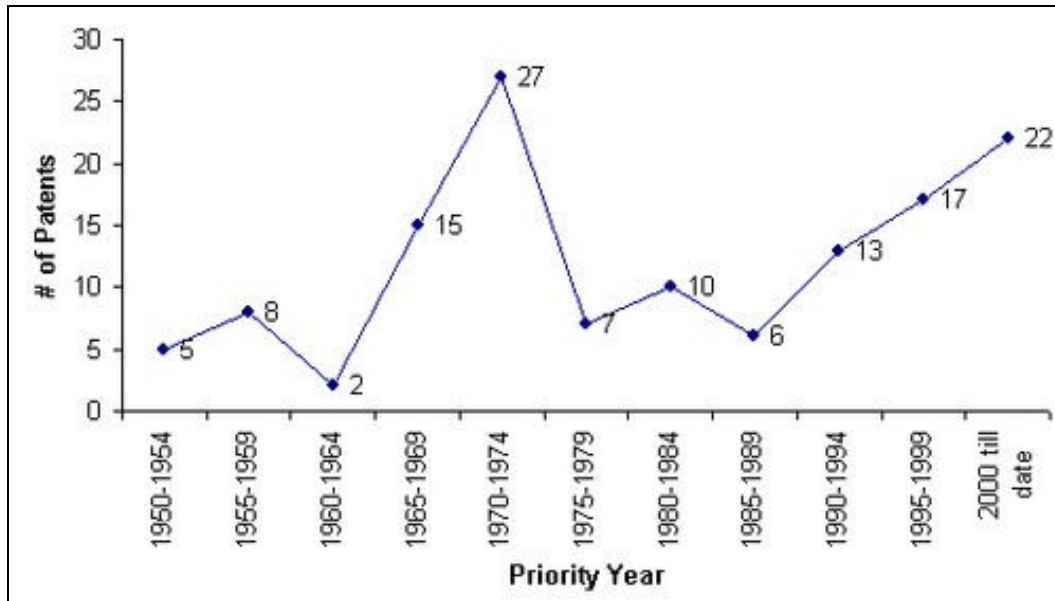

Year wise IP activity
Competitive analysis

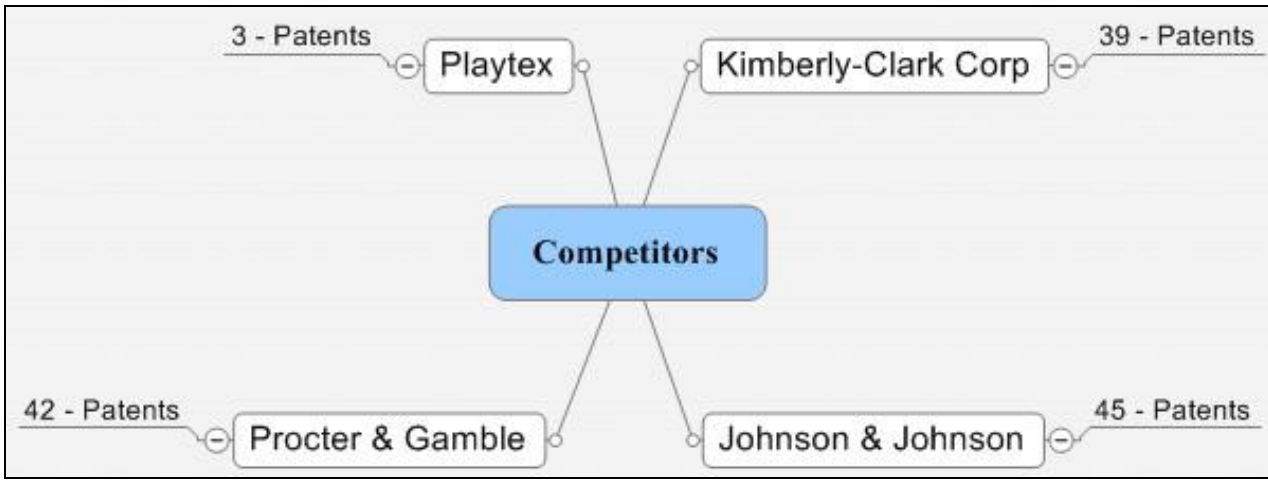

Competitive analysis
Sample analysis of some patents

• This information is according to analysis of 27 patents.

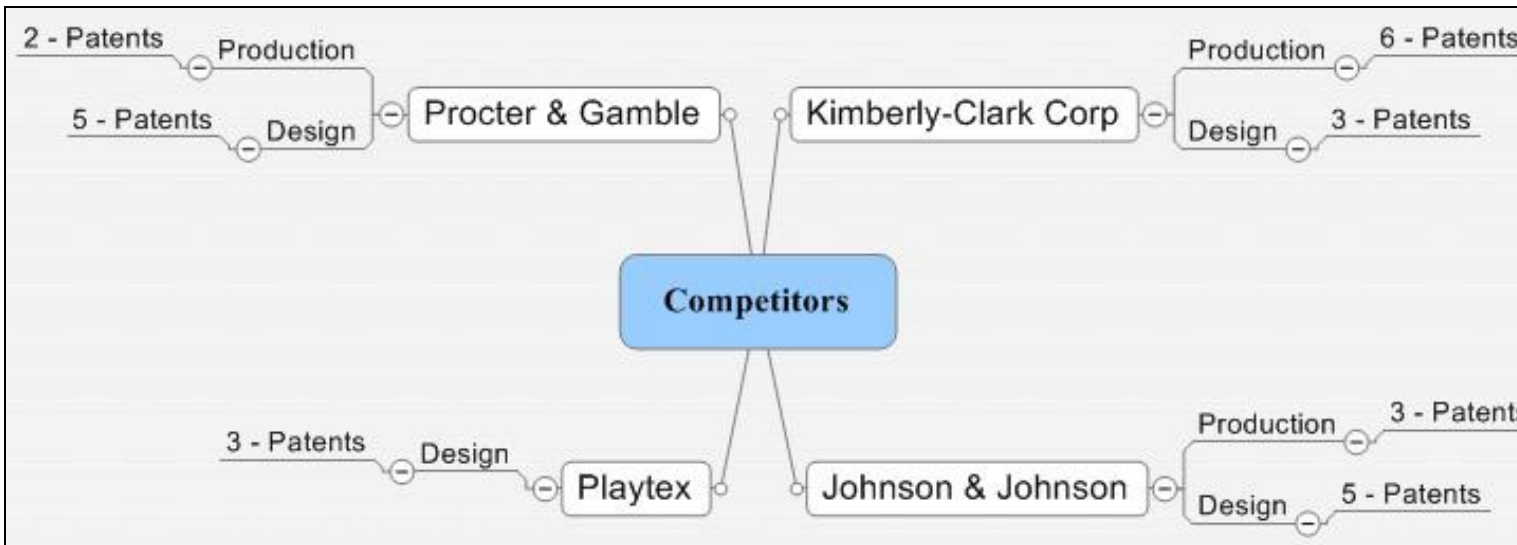

Sample analysis
Design patents

• **Classification of Design patents**

| Design | Total records | Kimberly Clark | Procter & Gamble | Johnson & Johnson | Playtex |
|-----------------------------|---------------|----------------|------------------|-------------------|---------|
| Absorbent pad | 11 | 2 | 5 | 4 | 0 |
| Attaching napkin to garment | 1 | 1 | 0 | 0 | 0 |
| Fastening means | 1 | 0 | 0 | 1 | 0 |
| Shoulder strap pad for bra | 1 | 0 | 0 | 0 | 1 |
| Tampon | 2 | 0 | 0 | 0 | 2 |

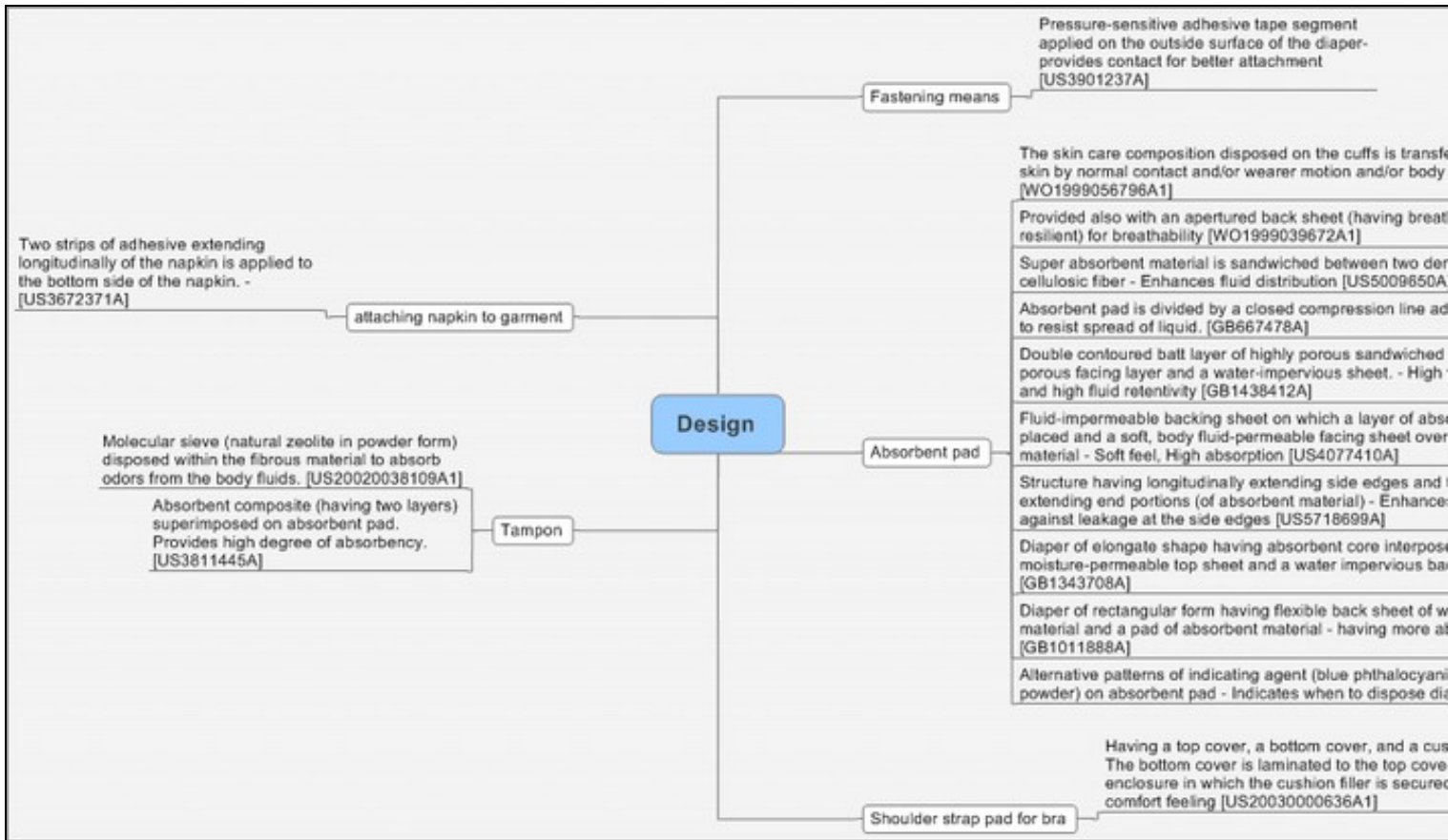

Design patents
Pictorial analysis

Absorbent pad

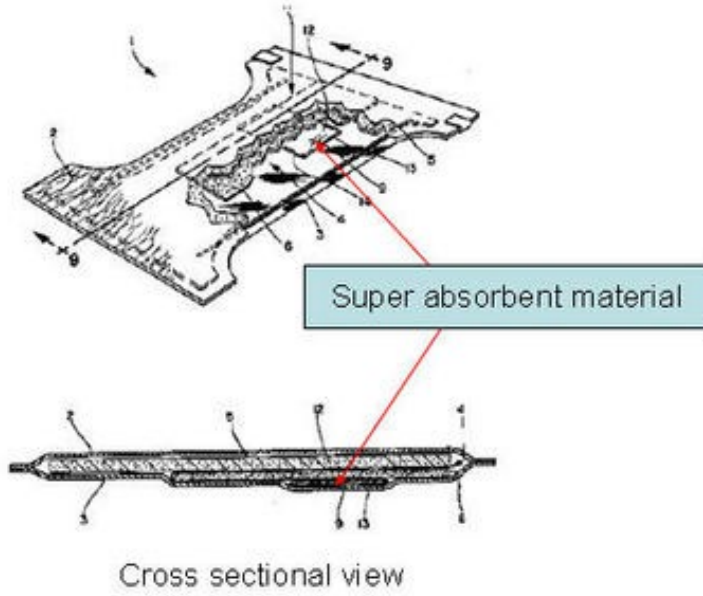

Super absorbent material (hydrocolloid materials) is sandwiched between two densified layers of cellulosic fiber - Enhances fluid distribution



Attaching napkin to garment

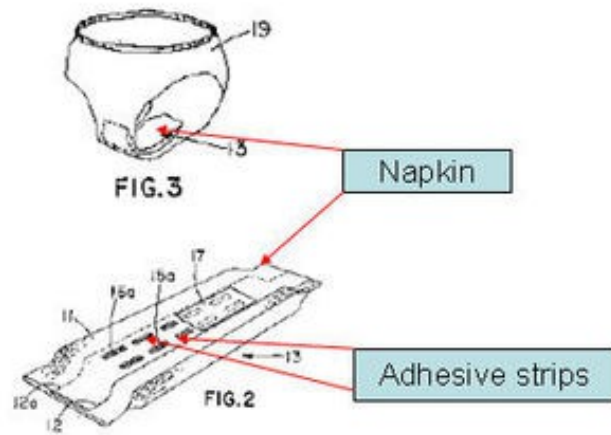

Two strips of adhesive extending longitudinally of the napkin is applied to the bottom side of the napkin. – For better attachment of napkin to garment



Fastening means

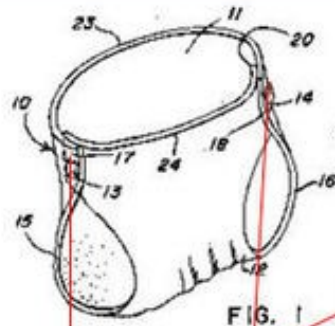

Closed view of diaper

FIG. 1

Pressure sensitive adhesive tap

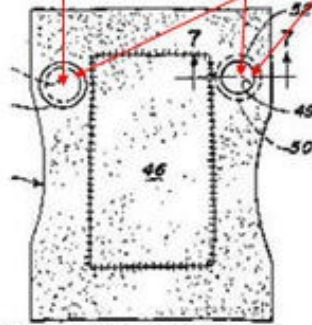

Open view of diaper

Pressure-sensitive adhesive tape segment applied on the outside surface of the diaper. - contact for proper attachment
 Adhesive surface of the fastening means is covered with a release sheet means which is readily removable upon use and preferably is permanently attached to the diaper - Adhesive material is not in contact with skin



Shoulder strap pad for bra

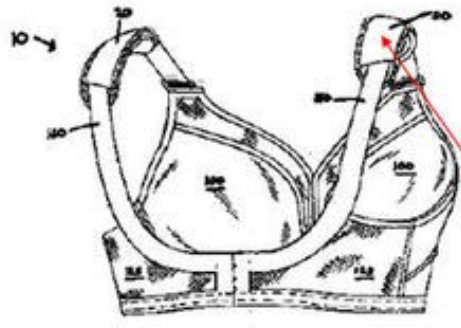

Fig. 1

Shoulder strap pad for bra

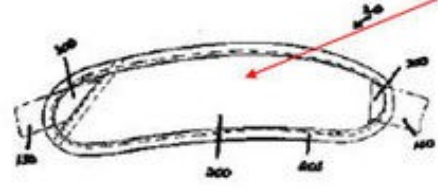
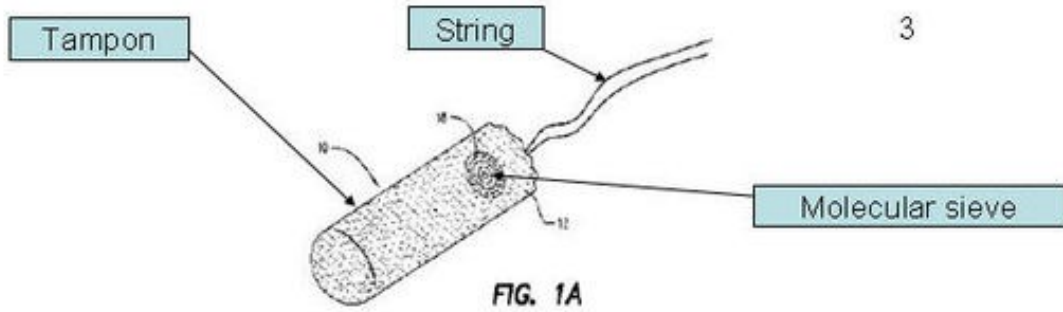

Fig. 2

Shoulder strap pad for bra having a top cover, a bottom cover, and a cushion filler. The bottom cover is laminated to the top cover to form an enclosure in which the cushion filler is secured. - For comfort feeling





Molecular sieve (natural zeolite in powder form) disposed within the fibrous material to absorb odors from the body fluids.



Production patents

• Classification of Production patents

| Production | Total records | Kimberly Clark | Procter & Gamble | Johnson & Johnson | Playtex |
|----------------------------|---------------|----------------|------------------|-------------------|---------|
| Absorbent pad | 6 | 2 | 2 | 2 | 0 |
| Odour removing composition | 2 | 1 | 1 | 0 | 0 |
| Wrapper | 1 | 1 | 0 | 0 | 0 |
| Elastic | 1 | 1 | 0 | 0 | 0 |
| Tampon | 1 | 1 | 0 | 0 | 0 |

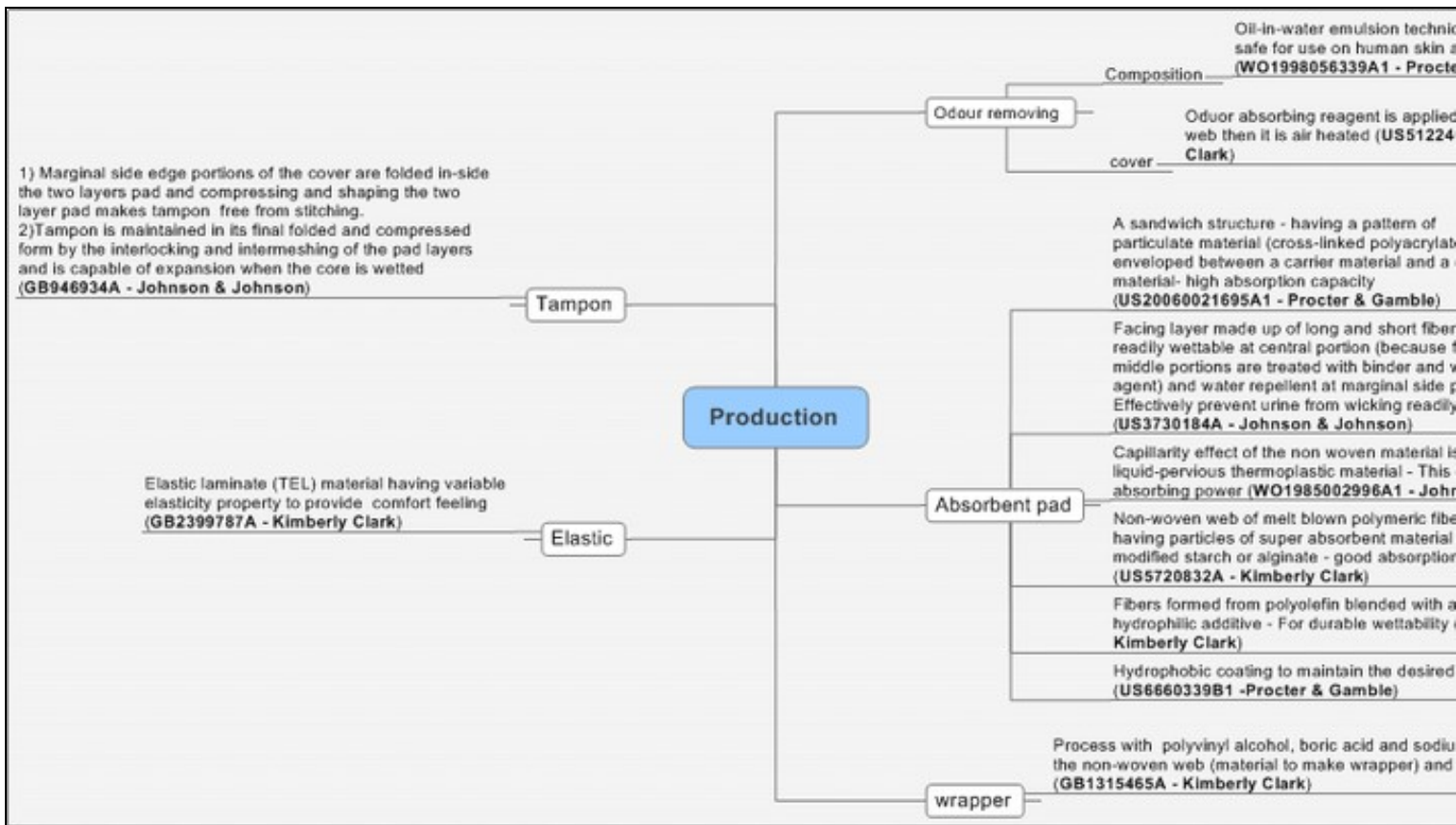

Production patents

Non Wovens for Skin care wipes

Like this report?

This is only a sample report with brief analysis
Dolcera can provide a comprehensive report customized to your needs

| Buy the customized report from Dolcera | | |
|--|--------------------------|---------------------------|
| Patent Analytics Services | Market Research Services | Purchase Patent Dashboard |
| Patent Landscape Services | Dolcera Processes | Industry Focus |
| Patent Search Services | Patent Alerting Services | Dolcera Tools |

Contact Dolcera

Samir Raiyani
Email: info@dolcera.com
Phone: +1-650-269-7952