

OLED - Organic Light Emitting Diode

This report presents a brief introduction to OLED (organic light emitting diode) and technologies available for top emission OLED. A detailed taxonomy for OLED is presented covering parts of the type of OLED, material used, manufacturing, applications among others. A detailed landscape analysis of patent and non-patent literature is done with a focus on Top Emission OLED (TEOLED). The product information of major players in the market is also captured for OLED. The final section of the report covers the existing and future market predictions for OLED.

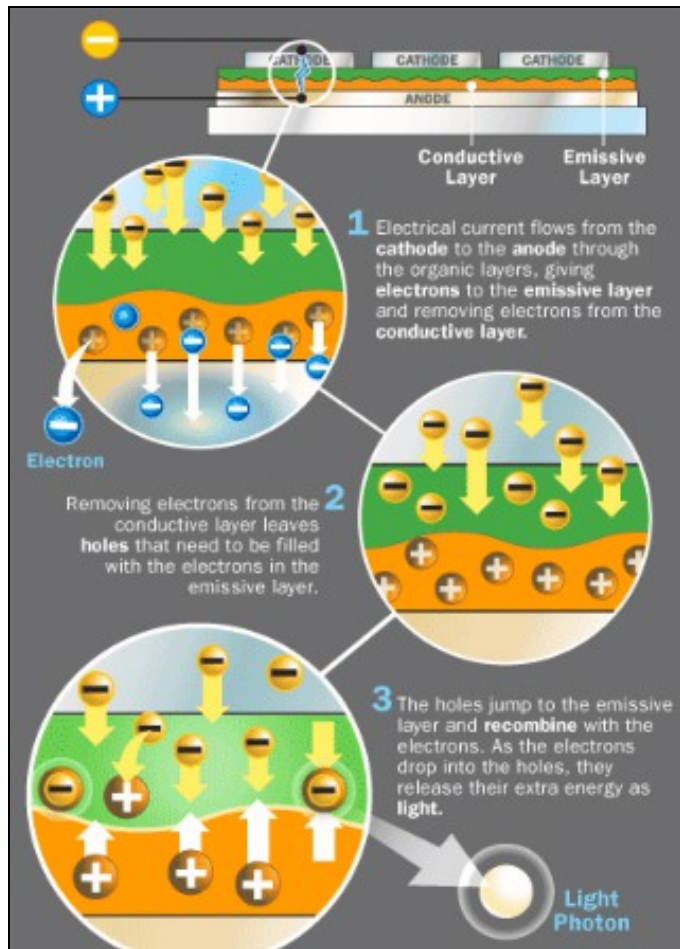

OLED Working Principle Contents

- 1 Introduction
 - ◆ 1.1 Read More?
- 2 Top Emission OLED: Search Strategy
 - ◆ 2.1 Control Patents
 - ◆ 2.2 Patent Classes
 - ◆ 2.3 Concept Table
 - ◆ 2.4 Micropatent Search Strategy
 - ◆ 2.5 Scientific Literature Search
 - ◆ 2.6 Search in Japanese database
- 3 Taxonomy
- 4 Sample Analysis
 - ◆ 4.1 Patent Analysis
 - ◆ 4.2 Article Analysis
 - ◆ 4.3 Top Cited Patents
 - ◆ 4.4 Top Cited Articles
- 5 Dolcera Dashboard
- 6 Products
- 7 Market Research
 - ◆ 7.1 Major Players
 - ◆ 7.2 Market Forecast
 - ◆ 7.3 Recent Licensing Activities in OLED Segment
 - ◆ 7.4 Landscape Analysis Of Top-Emission OLED
 - ◇ 7.4.1 Competitor Landscape
 - 7.4.1.1 Top Assignee
 - 7.4.1.2 Filing trends over the publication years
 - 7.4.1.3 Filing trends over the priority years
 - 7.4.1.4 Geographical Distribution based on family members
 - ◇ 7.4.2 Key Inventor Mapping
 - ◇ 7.4.3 Most Cited Patents
 - ◇ 7.4.4 Most Cited Patents Mapping
 - ◇ 7.4.5 Technology Mapping
 - 7.4.5.1 Comparison of out coupling of waveguiding light in top-emission polyLED stack
 - 7.4.5.2 Conclusion
 - ◆ 7.5 Like this report?

Introduction

- OLED technology was firstly developed in 1987 at Eastman Kodak Company by Tang and Van Slyke using small-molecule (sm-OLED). In 1990 Richard Friend, Jeremy Burroughes and Donal Bradley discovered electroluminescence capabilities from conjugated polymers so laying down the foundations for a new generation of flat panel displays.
- The growing number of electronic devices using organic light emitting diode displays shows that after years of promise, the technology is increasingly finding place in many products. But while OLED displays might challenge LCDs as the screens of choice for smaller gadgets, the technology may not become mainstream for notebook PCs or TVs within this decade.
- OLED displays use organic compounds that emit light when exposed to an electric current. They are brighter, have better contrast, offer wider viewing angles, use less power, and provide faster response times than liquid crystal displays. OLED screens' thickness is a third of that of LCDs, since they don't need a back-light, and that makes them a good fit for portable electronics devices.

Read More?

Click on [OLED Background](#) to read more about OLED.

Traditional light bulbs were invented more than 130 years ago. Since then the basic principle of creating light remains the same, although the design has been tweaked. An electric current passing through a tungsten wire causes it to heat up and glow white hot. Today, more than 20% of electricity used in US buildings is eaten up by lights and nearly half that amount is used by traditional, incandescent light bulbs. It has been a long-term goal of scientists to come up with something that would reduce this mammoth energy demand.

The OLEDs do not heat up like today's light bulbs and so are far more energy efficient and last longer. They also produce a light that is more akin to natural daylight than traditional bulbs. The new polymer uses a fluorescent blue material instead which lasts much longer and uses less energy.

Top Emission OLED: Search Strategy

The present study on the IP activity in the area of OLED with focus on *Top Emission OLED (TEOLED)* is based on a search conducted on Micropat.

Control Patents

S. No.	Patent/Publication No.	Publication Date(mm/dd/yyyy)	Assignee/Applicant	Title
1	US7791271B2	7/9/2010	Global OLED Technology LLC	Top-Emitting OLED Device With Light-Scattering Layer and Color-Conversion.
2	US7781961B2	08/24/2010	NovaLED AG	Top Emitting, Electroluminescent Component With Frequency Conversion Centres.
3	US7002293B2	02/21/2006	Eastman Kodak Company	Organic Light Emitting Diode With Improved Light Emission Through The Cathode.
4	US6770502B2	3/8/2004	Eastman Kodak Company	Method Of Manufacturing a Top-emitting OLED display Device with Desiccant Structures.
5	US20080169757A1	07/17/2008	TPO Displays Corp.	Top-Emitting Organic Electroluminescent Display
6	US20060043373A1	2/3/2006	Industrial Technology Research Institute	Method for Manufacturing a Pixel Array of Top Emitting OLED.
7	US20050236629A1	10/27/2005	Samsung Corp.	Top Emission Organic Light Emitting Diode Display Using Auxiliary Electrode to Prevent Voltage Drop of Upper Electrode and Method of Fabricating the Same.
8	EP1489671A2	12/22/2004	Global OLED Technology LLC	Method of Making a Top-Emitting OLED device having Improved Power Distribution
9	EP1029336A1	08/23/2000	Fed Corp.	Top Emitting OLED with Refractory Metal Compounds as Bottom Cathode .
10	WO2001057904A1	9/8/2001	Emagin Corp.	Low Absorption Sputter Protection Layer for OLED Structure.

Patent Classes

S. No.	Class No.	Class Type	Definition
1	257/40	USPC	Active solid-state devices (e.g., transistors, solid-state diodes) / Organic semiconductor material
2	257/E51.018	USPC	Active solid-state devices (e.g., transistors, solid-state diodes) / organic solid state devices, processes or apparatus peculiar to manufacture or treatment of such devices or of parts thereof / structural detail of device / light-emitting organic solid-state device with potential or surface barrier
3	257/E51.019	USPC	Active solid-state devices (e.g., transistors, solid-state diodes) / organic solid state devices, processes or apparatus peculiar to manufacture or treatment of such devices or of parts thereof / structural detail of device / light-emitting organic solid-state device with potential or surface barrier / Electrode
4	257/E51.02	USPC	Active solid-state devices (e.g., transistors, solid-state diodes) / organic solid state devices, processes or apparatus peculiar to manufacture or treatment of such devices or of parts thereof / structural detail of device / light-emitting organic

			solid-state device with potential or surface barrier / Electrode / Encapsulation
5	257/E51.021	USPC	Active solid-state devices (e.g., transistors, solid-state diodes) / organic solid state devices, processes or apparatus peculiar to manufacture or treatment of such devices or of parts thereof / structural detail of device / light-emitting organic solid-state device with potential or surface barrier / Electrode / Arrangements for extracting light from device (e.g., Bragg reflector pair)
6	257/E51.022	USPC	Active solid-state devices (e.g., transistors, solid-state diodes) / organic solid state devices, processes or apparatus peculiar to manufacture or treatment of such devices or of parts thereof / structural detail of device / light-emitting organic solid-state device with potential or surface barrier / Multicolor organic light-emitting device (OLED)
7	313/504	USPC	Electric lamp and discharge devices/solid-state type/ with particular phosphor or electrode material / Organic phosphor
8	H01L 27/28	IPC	Semiconductor devices; electric solid state devices not otherwise provided for / devices consisting of a plurality of semiconductor or other solid-state components formed in or on a common substrate / including components using organic materials as the active part, or using a combination of organic materials with other materials as the active part
9	H01L 27/32	IPC	Semiconductor devices; electric solid state devices not otherwise provided for / devices consisting of a plurality of semiconductor or other solid-state components formed in or on a common substrate / including components using organic materials as the active part, or using a combination of organic materials with other materials as the active part / with components specially adapted for light emission, e.g. flat-panel displays using organic light-emitting diodes
10	H01L 51/50	IPC	Semiconductor devices; electric solid state devices not otherwise provided for / solid state devices using organic materials as the active part, or using a combination of organic materials with other materials as the active part; processes or apparatus specially adapted for the manufacture or treatment of such devices, or of parts thereof / specially adapted for light emission, e.g. organic light emitting diodes (oled) or polymer light emitting devices (pled)
11	H01L 51/52	IPC	Semiconductor devices; electric solid state devices not otherwise provided for / solid state devices using organic materials as the active part, or using a combination of organic materials with other materials as the active part; processes or apparatus specially adapted for the manufacture or treatment of such devices, or of parts thereof / Details of devices
12	H01L 51/56	IPC	Semiconductor devices; electric solid state devices not otherwise provided for/specially adapted for sensing infra-red radiation, light, electromagnetic radiation of shorter wavelength, or corpuscular radiation; specially adapted either for the conversion of the energy of such radiation into electrical energy or for the control of electrical energy by such radiation / Processes or apparatus specially adapted for the manufacture or treatment of such devices or of parts thereo

Concept Table

S. No.	Concept 1	Concept 2
	Top emission	Organic Light Emitting Diode
1	top emitting	oled
2	top emissive	polymer led
3	top emission	light emitting polymer diode
4	toled	organic led
5	teoled	organic electroluminescent diode
6		foled
7		sm-oled
8		small molecule oled
9		amoled
10		pmoled

Micropatent Search Strategy

Database: Micropat

Patent coverage: US, EP, WO, JP, DE, GB, FR

Time line: 1836/01/01 to 2011/02/20

S. No.	Concept	Scope	Search String	No. of Hits
--------	---------	-------	---------------	-------------

1	Classes - OLED	Any Classification	H01L005150* OR H01L005152* OR H01L005156 OR H05B003308P OR 257E51.022	63152
2	Classes - Organic Semiconductor Devices	Any Classification	313504 OR 257040 OR 257E51.018 OR 257E51.019 OR 257E51.020 OR 257E51.021 OR H01L002728 OR H01L002732	27601
3	Top Emission keywords	Claims, Title or Abstract	((top emitting) OR (toled) OR (teoled) OR (te-oled) OR (top ADJ2 emitting) OR (top ADJ2 emissive) OR (top ADJ2 emission)) ADJ ((light ADJ emitting ADJ polymer) OR (organic ADJ electro-luminescence ADJ diode) OR (ORganic ADJ electroluminescent ADJ diode) OR (polymer ADJ light ADJ emitting ADJ diode) OR (ORganic ADJ light ADJ emitting ADJ device) OR (self-luminous ADJ diode) OR (oled) OR (organic led arrays) OR (organic ADJ light ADJ emitting ADJ diode) OR (organic ADJ light ADJ emission ADJ diode) OR (polymer ADJ light ADJ emission ADJ device) OR (organic ADJ electroluminescent device) OR (oel) OR (oleds))	1141
4	OLED keywords	Claims, Title or Abstract	((organic OR (small adj molecule*1) OR polymer*1) adj (lightemitting OR (light adj (emitting OR emission)) OR electroluminescen*2 OR (electro adj luminescen*2))) NEAR3 diode*1) OR oled*2 OR smled*2 OR pled*2 OR (light adj (emitting OR emission) adj polymer*1) OR ((organic OR (small adj molecule*1) OR polymer*1) NEAR3 led*2)	39392
5	Top emissioin OLED keywords	Claims, Title or Abstract	(((((organic OR (small ADJ molecule*1) OR polymer*1) ADJ (lightemitting OR (light ADJ (emitting OR emission)) OR electroluminescen*2 OR (electro ADJ luminescen*2))) NEAR3 diode*1) OR oled*2 OR smled*2 OR pled*2 OR (light ADJ (emitting OR emission) ADJ polymer*1) OR ((ORganic OR (small ADJ molecule*1) OR polymer*1) NEAR3 led*2)) AND ((top ADJ3 (emissi*2 OR emitting)))) OR (te ADJ oled*2)	429
6	Top Emission keywords AND OLED classes	Combined query	1 AND 3	809
7	LED Keywords	Claims, Title or Abstract	((lightemitting OR (light ADJ (emitting OR emission)) OR electroluminescen*2 OR (electro ADJ luminescen*2)) NEAR3 diode*1) OR led*2 OR oled*2 OR smled*2 OR pled*2	1617014
8	Top emission keywords AND Organic semiconductor devices classes AND Top emission keywords	Combined query	2 AND 7 AND 3	224
9	Top emissioin OLED keywords	Full patent spec.	(((((organic OR (small ADJ molecule*1) OR polymer*1) ADJ (lightemitting OR (light ADJ (emitting OR emission)) OR electroluminescen*2 OR (electro ADJ luminescen*2))) near3 diode*1) OR oled*2 OR smled*2 OR pled*2 OR (light ADJ (emitting OR emission) ADJ polymer*1) OR ((organic OR (small ADJ molecule*1) OR polymer*1) near3 LED*2)) near3 ((top ADJ3 (emissi*2 OR emitting)))) OR (te ADJ oled*2)	1506
10	German Keywords	Full patent spec.	((top adj3 (emissi*2 OR emitting)) OR (Top NEAR2 emittierende*1)) NEAR3 ((organische NEAR2 (led*1 OR Leuchtdiode*1)) OR (Licht adj emittierende adj Polymer*1) OR oled*1)	1430
11	French Keywords	Full patent spec.	((top ADJ3 (émissive OR émettant)) OR (démission ADJ top) OR (top ADJ3 (emissi*2 OR emitting))) NEAR3 ((diode*1 NEAR3 électroluminescente NEAR3 organique*1) OR ((Polymère*1 OR organiques) ADJ2 led*1) OR (polymère*1 NEAR3 émettant NEAR3 lumière) OR oled*1)	1412
12		Combined query	5 OR 6 OR 8 OR 9 OR 10 OR 11	2113 (1132 unique)
13	Control Patents	Patent/Publication No.	WO2001057904A1 OR EP1029336A1 OR EP1489671A2 OR US20050236629A1 OR US20060043373A1 OR US20080169757A1 OR US6770502B2 OR US7002293B2 OR US7781961B2 OR US7791271B2	10
14		Combined query	12 AND 13	10

Scientific Literature Search

S.No	Database	Query	Limits by Date	No.Of Hit
1	Google scholar	(Top emitting or top emission or top emissive) and ((organic light emitting diode) or (polymer led) or (light emitting polymer led) or (OLED))	1990-2011	1840

Search in Japanese database

Database: IPDL (Industrial property digital library), Japan

Date of search: 1900/01/01 to 2011/02/15

S.No.	Issue/Publication date	F-Term Theme	FI/F-term/Facet
-------	------------------------	--------------	-----------------

1	1900/01/01 to 2011/03/02	3K107	DD03*[AA01+BB01+BB02+BB03+BB04+BB05+BB06+BB07+BB08+DD01+DD04+DD42+DD50+CC01+CC02+CC04+CC08+CC09+EE02+EE03+EE06+EE22+GG01+GG02+GG03+GG04+GG05+GG06+GG07+GG08+GG08]
---	-----------------------------	-------	---

• F-Terms and theme used in search

Japanese F-term search			Definition
Sr. No.	F- Term theme	3K107	
			Electroluminescent light sources
1	F- Term	AA01	Organic electroluminescent element.
2	F- Term	BB01	Used in displays.
3	F- Term	BB02	Used in Lights or light sources
4	F- Term	BB03	Used in Backlights or the like for liquid crystals
5	F- Term	BB04	Used in printer heads
6	F- Term	BB05	Used in lasers
7	F- Term	BB06	Used in designs or advertisements
8	F- Term	BB07	Used in timepieces
9	F- Term	BB08	Used in on-board use
10	F- Term	DD01	Having feature of all direction of light emission.
11	F- Term	DD03	Having top emission.
12	F- Term	DD04	Having double sided emission.
13	F- Term	DD42	Having Organic materials.
14	F- Term	DD50	Structured with Light emitting layers
15	F- Term	CC01	Having Light emitting layers
16	F- Term	CC02	Light emission characteristics were improved.
17	F- Term	CC04	Has an effect on brightness.
18	F- Term	CC06	Has an effect on efficiency
19	F- Term	CC07	Has an effect on colours.
20	F- Term	CC08	Has an effect on Colour purity; Colour temperatures; Light emission wavelengths, including UV
21	F- Term	CC09	Has colour balance feature
22	F- Term	EE02	Has white light emission.
23	F- Term	EE03	Display having Passive matrices
24	F- Term	EE06	Display having Active matrices
25	F- Term	EE22	Display having with RGB picture elements having different areas
26	F- Term	GG01	Dispaly having color filters.
27	F- Term	GG02	Apparatus for deposition
28	F- Term	GG03	Apparatus for dry methods
29	F- Term	GG04	Apparatus for chemical vapour deposition
30	F- Term	GG05	Apparatus for evaporation
31	F- Term	GG06	Apparatus for sputtering
32	F- Term	GG07	Apparatus for wet methods
33	F- Term	GG08	Apparatus for printing
34	F- Term	GG08	Apparatus for Inkjet

Taxonomy

```

.markmap-node {
  cursor: pointer;
}

.markmap-node-circle {
  fill: #fff;
  stroke-width: 1.5px;
}

.markmap-node-text {
  fill: #000;
  font: 10px sans-serif;
}

.markmap-link {
  fill: none;
}

pre, .mw-code{
  background-color: transparent;
}
d3.xml("https://www.dolcera.com/wiki/images/OLED_Taxonomy.mm", function(error, data) {
  if (error) throw error;

  markmap("svg#mindmap_68bd62c25a72c7916a54b991c5cf7bd7", data, {
    preset: "colorful",
    linkShape: "diagonal"
  }, "xml");
});

```

Sample Analysis

Patent Analysis

A sample of 200 patents from the search is analyzed based on the taxonomy. Provided a link below for sample spread sheet analysis for Top Emission OLED.

S.No	Patent/Publication No.	Date of Publication	Assignee / Applicant	Title	Problem	Solution
1	US7692191B2	04/06/2010	Samsung Mobile Display Co., Ltd.	Top-emitting organic light emitting device	In the conventional top-emitting organic light emitting device, each pixel electrode is designed to have a minimum width, and neighboring pixel electrodes are designed to be widely spaced apart from each other by as much as 17 .mu.m. Therefore, the wide space between the pixel electrodes leaks emitted light, thereby deteriorating the voltage-current characteristics of the thin film transistors i.e., increasing photo-leakage.	In this patent the top-emitting organic light emitting device has maximized the width of a pixel electrode, thereby enhancing aperture ratio. Furthermore, the pixel electrode is arranged to overlap all thin film transistors, so that light is prevented from leaking through a space between neighboring pixel electrodes, thereby reducing photo-leakage of the thin film transistor.
2	US7554259B2	06/30/2009	Sanyo Electric Co., Ltd.	Light emitting display apparatus having excellent color reproducibility	Organic electroluminescence panel obtains white light by synthesizing two lights each having complementary color to the other, and the three primary colors differ in luminous intensity. Therefore it is difficult to set chromaticity of white light to desired level. And even after color-filter transmission, red light and blue light will have stronger luminous intensity than green light.	The present invention objective provide a light emitting display apparatus having excellent color reproducibility. Organic light emitting layer that synthesizes two or more complementary colors of light that are complementary to each other thereby producing white light. It has a resonant structure by which a resonant wavelength is set to a predetermined wavelength, and

						<p>outputs the white light via the resonant structure where the predetermined wavelength substantially coincides with a wavelength corresponding to a primary color whose luminous intensity is uniform. With the stated construction, non-uniformity in luminous intensity among three primary colors is alleviated by means of amplified luminous intensity due to resonance. This will help obtain white light in which the primary colors are balanced well.</p>
3	US7332859B2	02/19/2008	Canon Kabushiki Kaisha	Organic luminescence device with anti-reflection layer and organic luminescence device package	<p>In organic luminescence device, the transparent electrode is formed by a material of a refractive index higher than that of air or nitrogen, constituting the external environment of the organic luminescence device. Therefore, the light emitted from the light emitting layer is reflected at a light emitting surface of the transparent electrode, namely at the interface between the transparent electrode and the air constituting the external environment in FIG. 1. For this reason, such organic luminescence device has been associated with a low efficiency of light emission to the exterior.</p>	<p>The present invention is to provide an organic luminescence device of a high light-emitting efficiency to the exterior and an organic luminescence device of a satisfactory contrast. A case holding the organic luminescence device in an internal holding space, in which a light emitted from the organic luminescence device, is emitted to the exterior through a light emitting side of the case; wherein anti-reflection means is provided on a light-emitting face on the light-emitting side among faces constituting the internal holding space of the case</p>
4	US6885157B1	04/26/2005	Eastman Kodak Company	Integrated touch screen and OLED flat-panel display	<p>It has the problem of multiple external electrical connections by employing a flat-panel display having a substrate that extends beyond the substrate of the resistive touch screen.</p>	<p>The present invention has the advantage that it reduces the costs and improves the reliability and performance of a touch screen that is used with an OLED flat-panel display by integrating cable connections on a single substrate and providing touch screen signal processing on the display substrate.</p>
5	US6069443A	05/30/2000	FED Corporation	Passive matrix OLED display	<p>The disadvantage of oxygen and moisture penetration into the</p>	<p>The present invention to provide an</p>

					interior of the organic light emitting device is the potential to form metal oxides at the metal-organic interface. These metal oxide impurities may allow separation of the cathode or anode and the organic in a matrix . This can result in the formation of dark non-emitting spots (i.e., no illumination).Edge shorting between the cathode and anode layers is a current problem affecting most conventional organic light emitting display devices. This edge shorting reduces the illuminating potential of the display devices.	insulator layer to minimize edge shorts between lines by separating the OLED layer and the electrode elements. It also provides a sealing structure to isolate the OLED layer from moisture and other contaminants.
6	US20110031511A1	02/10/2011	None	ORGANIC LIGHT EMITTING DIODE DISPLAY AND METHOD OF MANUFACTURING THE SAME	In the organic light emitting layer, as it is easy to transfer energy in an interface between a light emitting layer and a hole transfer layer, a light emitting efficiency and lifetime of the OLED display are reduced because of an energy loss of triplet inside the OLED display.	An interface of the light emitting layer can be improved by forming the inorganic oxide layer between the hole transport layer and the light emitting layer. Further, an energy loss of triplet can be prevented, and the emission efficiency and lifetime can be improved.
7	US20070153051A1	07/05/2007	Samsung Electronics Co., Ltd.	Manufacturing flat panel displays with inkjet printing systems	For manufacture of certain flat panel display devices, such as LCDs or OLED displays, various thin film patterns are formed on panel substrates of the devices, typically using photolithography processes. However, as displays become larger, the amount of material that must be deposited on substrates to form the thin film patterns also becomes larger, inturn increases the manufacturing costs of the panels.	Inkjet printing systems have been developed for forming the thin film patterns on the substrates by depositing them on the substrates in the form of special inks. These systems deposit the ink on the substrate through an inkjet head. However, the inkjet head includes a plurality of nozzles, and if only one of these nozzles becomes dysfunctional, the number of passes that the inkjet printing head must make increases. As a result, processing time and costs are substantially increased.
8	US6911671B2	06/28/2005	Eastman Kodak Company	Device for depositing patterned layers in OLED displays	To achieve color pixelation in OLED imaging panels, fabrication of a multicolor OLED imaging panel using a shadow masking method is used. A multicolor organic electroluminescent ("EL") medium is vapor deposited and patterned by controlling an angular position of a substrate with respect to a	The present invention is that a pattern of vaporized material, such as organic material, can be deposited without the use of shadow mask. Another feature is that a plurality of devices can be used for simultaneously depositing different organic

					deposition vapor stream. The positioning an element in direct contact with a surface of a substrate can invite problems of abrasion, distortion, or partial lifting, this may cause abrasion, distortion, or partial lifting of the first-color pattern.	materials. Such organic materials can emit light in different ranges of the spectrum.
9	US7218295B2	05/15/2007	AU Optronics Corp.	Driving method for active matrix OLED display	In one display frame, the current received by the OLED is fixed. The driving method used previously accumulates carriers inside the OLED which reduce the life of the OLEDs. Moreover, the voltage across the OLED gradually increases over time which in turn increases power. This effects the OLED over time.	The present invention uses a driving method to neutralize carrier accumulation in the OLED, thereby reducing the increase in voltage and minimizing the increase in power consumption across both ends of the OLED over time, further increasing the life of the OLED.
10	US7067170B2	06/27/2006	Eastman Kodak Company	Depositing layers in OLED devices using viscous flow	To achieve color pixelation in OLED imaging panels, fabrication of a multicolor OLED imaging panel using a shadow masking method is used. A multicolor organic electroluminescent ("EL") medium is vapor deposited and patterned by controlling an angular position of a substrate with respect to a deposition vapor stream. The positioning an element in direct contact with a surface of a substrate can invite problems of abrasion, distortion, or partial lifting, this may cause abrasion, distortion, or partial lifting of the first-color pattern.	The present invention is that the method of color pixelating an organic layer includes providing a plurality of vapor sources disposed outside of a deposition chamber for generating vapors of organic materials, and connecting such vapor sources to a manifold disposed in the chamber. By using vapor deposition method, we can eliminate precision shadow masks.

Click [here](#) to view the detailed analysis sheet for doubly-fed induction generators patent analysis.

Article Analysis

S.No.	Title	Authors	Publication date	Journal/Conference	Dolcera summary.
1	Application of Screen Printing in the Fabrication of Organic Light-Emitting Devices	Dino A. Pardo, Ghassan E. Jabbour,* and Nasser Peyghambarian	01/27/2000	Optical Sciences Center, University of Arizona. IEEE 27 Jan 2000	This article explains the screen printing technique which deposits organic active layer having a thickness of several tens of nanometers and acting as a hole-transport layer (HTL) in multilayer OLEDs. The resulting devices emit light at low voltage (<5 V) and have a peak external quantum efficiency of 0.91 %.
2	Multicolor Organic Light-Emitting Diodes Processed by Hybrid Inkjet Printing	Shun-Chi Chang, Jie Liu, Jayesh Bharathan, Yang Yang,* Jun Onohara and Junji Kido	08/07/1999	Department of Materials Science and Engineering University of California at Los Angeles. willey 8 Jul 1999	This article presents a multicolor patterning technique to produce controllable patterning of red-green-blue OLEDs with fine pixel displays. The LEDs comprise bilayer structures of red and green dopants with inkjet-printed onto a film of the blue-emitting semiconducting polymer, the latter serving as the hole-transport layer.
3	Organic light-emitting diode (OLED) technology: materials, devices and	Bernard Geffroy, Philippe le Roy and Christophe Prat	06/02/2006	Laboratoire Cellules et Composants. willey 6 Feb 2006	This article presents an overview of OLED's over LCD's. OLED'S have a thickness, currently less than 2 mm. Having high contrast ratio is also a

	displaytechnologies				strong point of OLED and also in fast response time.OLEDs for flat-panel display applications are their self-emitting property, high luminous efficiency, full-colour capability, wide viewing angle, high contrast,low power consumption, low weight, potentially large area colour displays and flexibility.
4	Organic/polymeric electroluminescent devices processed by hybrid ink-jet printing	Yang Yang, Shun-Chi Chang, Jayesh Bharathan and Jie Liu	04/05/1999	Journal of Materials Science: Materials in Electronics Volume 11, Number 2,	The HIJP concept is a unique approach for fabricating polymer and organic electronic devices. One is able to apply this technology for the deposition of various functional materials such as charge-injection layers, charge-blocking layers, and multicolor polymer/organic emissive layers. It can be used for the fabrication of logos, indicator lights, multicolor displays and also in bio-medical applications such as biosensors for low cost diagnostics.
5	White Organic Light-Emitting Devices for Solid-State Lighting	B. W. D'Andrade, S. R. Forrest	14/10/2004	Department of Electrical Engineering, Princeton University Willey 14 OCT 2004	This article presents the WOLEDs increasing display applications for use primarily as liquid-crystal display backlights. They have achieved high material purity, low cost, high brightness,color quality and long operational life-times.
6	White organic light-emitting diodes with fluorescent tube efficiency	Sebastian Reineke, Frank Lindner, Gregor Schwartz, Nico Seidler, Karsten Walzer	14/05/2009	Institute of Applied Photophysics. Vol 459 Macmillan Pub	This article presents an WOLED havinh high internal quantum efficiencies for the con-version of electrical energy to light have been realized by focussing on reducing energetic and ohmic losses that occur during electron?photon conversion.This can be achieved by improved OLED structure which reaches fluorescent tube efficiency. By combining a care-fully chosen emitter layer with high-refractive-index substrates and using a periodic outcoupling structure
7	Precision ink jet printing of polymer light emitting displays	J. F. Dijkstra, P. C. Duineveld, M. J. J. Hack, A. Pierik, J. Rensen, J.-E. Rubingh, I. Schram andM. M. Vernhou	09/11/2006	Philips Research Laboratories RSC	Precision ink jet printing of organic polymer light emitting diodes relies strongly on the accuracy of the droplet generation process.Image capturing using one image at a time for image processing delivers sharper images and can be used for optically measuring droplet volumes.
8	High-efficiency microcavity top-emitting organic light-emittingdiodes using silver anode	Huajun Peng, Jiaxin Sun, Xiuling Zhu, Xiaoming Yu, Man Wong, and Hoi-Sing Kwok	17/02/2006	Hong Kong Universityof Science and Technology. AIP	High efficient top-emitting OLEDs have been fabricated using highly reflective Ag as the anode. Surfacemodification of the Ag anode by CF4 plasma substantially enhances the hole injection efficiency. The color variation isalmost eliminated in the TOLED. The optimized microcav- ity TOLED has a current efficiency enhancement of 65% and a total outcoupling efficiency enhancement of 35%, as compared with a conventional OLED.
9	Inverted top-emitting organic light-emitting diodes using transparent conductive NiO electrode	Se-W. Park, Jeong-M. Choi, Eugene Kim and Seongil Im	09/01/2005	Institute of Physics and Applied Physics, Applied Surface Science 244 (2005) 439?443	TE-OLED device uses a thermally evaporated and semi-transparent NiO film as a top-electrode. Since the sheet resistance of our NiO was very high and its transmittance was only about 50%, the resulting luminance and injection current of our TE-OLED were much inferior to those of the BE-OLED device.
10	Self-assembled monolayer-modified Ag anode for top-emitting polymerlight-emitting diodes	Lai-Wan Chong, Yuh-Lang Lee,a? and Ten-Chin Wenb?	07/12/2006	Department of Chemical Engineering, National Cheng Kung University	Self-assembled monolayer is a method to modify the Ag anodes for application in T-PLED. The Ag electrode can be utilized as an effective anode to improve the emitting characteristic of a T-PLED. The Ag anode enhances the hole injection, reduce the op-eration voltage, and significantly increase the current inten-sity and luminous efficiency of the device, without decreasing the reflectivity of the Ag anode.

Click [here](#) to view the detailed analysis sheet for Top Emission OLED for non patent literature

Top Cited Patents

S. No.	Patent/Publication No.	Publication Date (mm/dd/yyyy)	Assignee/Applicant	Title	Citation Count
1	US6096496A	8/1/2000	Frankel; Robert D	Supports incorporating vertical cavity emitting lasers and tracking apparatus for use in combinatorial synthesis	130
2	US6069443A	5/30/2000	Fed Corporation	Passive matrix OLED display	97
3	US6366017B1	4/2/2002	Agilent Technologies	Organic light emitting diodes with distributed bragg reflector	80
4	US20020197511A1	12/26/2002	United Of America As Respresented By The Secretary Of The Air Force	High efficiency multi-color electro-phosphorescent OLEDs	51
5	US6265820B1	7/24/2001	Emagin Corporation,De	Heat removal system for use in organic light emitting diode displays having high brightness	50
6	US20020195968A1	12/26/2002	IBM	Oled current drive pixel circuit	44
7	US20020186209A1	12/12/2002	Eastman Kodak Company	Touch screen for use with an OLED display	42
8	US20030127973A1	7/10/2003	Universal Display Corporation	OLEDs having increased external electroluminescence quantum efficiencies	41
9	US6844673B1	1/18/2005	Alien Technology Corporation	Split-fabrication for light emitting display structures	38
10	US20040174116A1	9/9/2004	Universal Display Corporation	Transparent electrodes	36
11	US20050194896A1	9/8/2005	Hitachi Displays Ltd.	Light emitting element and display device and illumination device using the light emitting element	35
12	US20020074935A1	6/20/2002	Universal Display Corporation	Highly stable and efficient OLEDs with a phosphorescent-doped mixed layer architecture	35
13	US20040217702A1	11/4/2004	Corning Incorporated	Light extraction designs for organic light emitting diodes	33
14	US20020030647A1	3/14/2002	Universal Display Corporation	Uniform active matrix oled displays	32
15	US20050248270A1	11/10/2005	Eastman Kodak Company	Encapsulating OLED devices	31
16	US20040113875A1	6/17/2004	Eastman Kodak Company	Color oled display with improved power efficiency	29
17	US20030230972A1	12/18/2003	Eastman Kodak Company	Oled display having color filters for improving contrast	28
18	US20050040756A1	2/24/2005	Eastman Kodak Company	OLED device having microcavity gamut subpixels and a within gamut subpixel	27
19	US6670772B1	12/30/2003	Eastman Kodak Company	Organic light emitting diode display with surface plasmon outcoupling	26
20	US20040061136A1	4/1/2004	Eastman Kodak Company	Organic light-emitting device having enhanced light extraction efficiency	26

Top Cited Articles

S. No.	Title	Publication Date	Journal/Conference	Citations Count
1	Electroluminescence from single monolayers of nanocrystals in molecular organic devices	Oct 2002	Nature, Internatinal journal of science.	736
2	Spin-dependent exciton formation in π-conjugated compounds	Aug 2001	Nature, Internatinal journal of science.	220
3	Highly Efficient Organic Devices Based on Electrically Doped Transport Layers	Mar 2007	American Chemical Society Pub.	211
4	Phosphorescent top-emitting organic light-emitting devices with improved light outcoupling	Nov 2002	Applied Physics Letters / Volume 82	111
5	Thin-film permeation-barrier technology for flexible organic light-emitting devices	Jan 2004	IEEE Photonics Society	104

6	Design of flat-panel displays based on organic light-emitting devices	Feb 1998	IEEE Photonics Society	100
7	A new a-Si:H thin-film transistor pixel circuit for active-matrix organic light-emitting diodes	Aug 2003	IEEE Electron Devices Society	86
8	The road to high efficiency organic light emitting devices	Sep 2003	ScienceDirect	87
9	Amorphous silicon thin film transistor circuit integration for organic LED displays on glass and plastic	Sep 2004	IEEE Photonics Society	73
10	Transparent-cathode for top-emission organic light-emitting diodes	Feb 2003	Applied Physics Letters	72

Dolcera Dashboard

Dashboard Link

[Top Emission OLED - Dashboard](#)



- Flash Player is essential to view the Dolcera dashboard

Products

S. No.	Company	Product	Specifications	
1	Sony		Digital Inputs Specifications	Detail:
			HDMI	HDMI (x1) (HDCP correspondence, Deep Color correspondence)
			SDI (SMPTE 259M)	BNC (x2)
				Detail:



BVME250

Display Specifications	
Image Aspect Ratio	16:09
Resolution	1920 x 1080 pixels (Full HD)
Screen Size	24 5/8 inches (623.4 mm)
Viewing Angle	89°/89°/89°/89°
General Specifications	Detail:
Dimensions (W x H x D)	22 3/4 x 16 3/4 x 5 7/8 inches
Weight	28 lb 11 oz
Power Requirements Specifications	Detail:
Power Consumption	Approx. 145 W
Power Requirements	AC 100 V to 240 V, 1.6 A to 0.8 A, 50/60 Hz

2

Sony



BVM-E170

Digital Inputs Specifications	Detail:
HDMI	HDMI (x1) (HDCP correspondence, deep colour correspondence)
SDI	BNC (x2)
Display Specifications	Detail:
Image Aspect Ratio	16:09
Resolution	1920 x 1080 pixels (Full HD)
Screen Size	365.8 x 205.7 mm (14 1/2 x 8 1/8 inches)
Viewing Angle	89°/89°/89°/89° (typical) (up/down/left/right contrast >10:1)
General Specifications	Detail:
Dimensions (W x H x D)	436.0 x 282.4 (266.4)* x 214.7 mm (17 1/4 x 11 1/4 (10 1/2)* x 8 1/2 inches)* Height without legs
Weight	8.5 kg (18 lb 11 oz)
Power Requirements Specifications	Detail:
Power Consumption	Approx. 65 W normally with input from a standard HDMI input. Approx. 115 W at

									maximum load, with four option slots in use and maximum luminance compensation for any deterioration due to aging.
								Power Requirements	AC 100 V to 240 V, 1.4 A to 0.7 A, 50/60 Hz DC 24 V to 28 V, 4.7 A to 4.0 A
3	Sony		PVM-740					Digital Inputs Specifications	Detail:
								HDMI	Yes
								HDSDI (SMPTE 292M)	3G/SDI/HDSDI
								SDI (SMPTE 259M)	Included
								Display Specifications	Detail:
								Back Light Technology	OLED
								Native Aspect Ratio	16:09
								Resolution	960 x 540
								Screen Size	Approx 7.4 inches
								Viewing Angle	85°/85°/85°/85° (typical) (up/down/left/right contrast>10:1)
								General Specifications Specifications	Detail:
								Dimensions (W x H x D)	8 7/8 x 7 1/4 x 6 3/8 inches Approx. 222.4 x 183.5 x 161.8 mm
								On-Screen Display	Yes
								Rack Mount	MB531
								Weight	Approx. 5 lb 12 oz Approx. 2.6 kg
								Power Requirements Specifications	Detail:
								Power Consumption	Max. approx. 27W
								Power Requirements	AC 100 to 240 V 50/60 Hz 0.5A to 0. DC 12 V 1.9 A Rechargeable Battery Pack

Market Research

Major Players

Major types of player	USA	EU	Japan	Korea	Taiwan	China
Original IPR for devices and for manufacture process + material supply / verification	UDC; Kodak; Add-Vision; Magin; Plextronics; Organic Lighting Technologies; GE;3M Innovation	CDT (Sumitomo Chemical) (UK); Novaled (G); Fraunhofer IPMS (G); OLED-T (UK); OTB (ND); MicroEmissive Displays (UK)	Seiko-Epson; Matsushita; Sony; Sumitomo Chemical; Sharp; TM Display; Konica ?Minolta; Sanyo; Toppoly; Lumiotec; Canon; Toshiba	Samsung; LG Phillips LCD; Neo View; Doosan DND	AU Optoelectronics (AUO); Univision; Toppoly; Tetrahedron; Chi Mei Optoelectronics	

Bulk materials and glass suppliers	PPG; 3M; Dow Corning	Merck Materials (G); BASF (G); CDT (UK); Degussa/ Evonik (G); HC Starck (G); Sensient Imaging Technologies (G); Goodfellow Metals (UK); Novald (G)	Sumitomo Chemical; Mitsubishi Chemical			Syndychem (Shenyang Syndy Chemistry Institute)
Components ? driver ccts., packaging etc	Corning; Rockwell Collins	ST Microelectronics (It, Fr); Infineon (G)	Maekawa; Matsushita; Toppoly	Dae Joo Electrnics	AUO; Richtek Technologies; Lightsonic; Univision; Wintek	Innocom Technologies Shenzhen; RIT Display
OEM OLED FPD screen manufacturer & resellers	eMagin; US Micro Products	Densitron Technologies (UK); MicroEmissive Displays (MED) (UK); Pacer International Distributors (UK reseller)	Seiko-Epson; Sharp; Sumitomo Chemical; Lumiotec; TMDisplay; Sanyo	Samsung SDI; Orion OLED; NeoView KOLON; Hyundai LCD	AUO; Chi Mei EL (CMEL); Univision Technology; Eversion Electronics; RiTDisplay; TPO Display	Visionix; Smartdisplays; Universal Display Technologoes (Jilin); Varitronix (HK); Blaze Display Technologies
Branded application device or/and FPD screen manufacturer with retail device sales	OSD	Nokia; Sony-Ericsson	Sony; Matsushita; Hitachi; Toshiba; Imase	Samsung; LG Philips		
OLED lighting branded suppliers and R&D	GE	Thorn EMI (UK); OSRAM (G); Siemens (G)	Sumitomo Chemica			

source: Major players

SWOT analysis

Strengths	Weaknesses
? Capability for innovation ? Production of base materials for OLED manufacture ? Process equipment manufacture is easy.	? Lack of industrial productive capacity or eco-system to support low-cost volume production ? Capability to bring innovations to market ? i.e. probability of export market success ? Lack of branded consumer goods suppliers apart from mobile handsets ? e.g. Nokia
Opportunities	Threats
? Possible renaissance in manufacturing at low-cost ? Use of IPR ? with mitigations through agreements ? Expansion in base materials supply and process equipment manufacture for low temperatures	? Older technologies ? TFT-LCDs which improve technically ? become cheaper, flexible, lower power demands and better colour/contrast, scale up larger, etc, make existing (LCD) players far stronger ? Strong competitive position and behaviour of current major players globally and market make market entry difficult or increasingly impossible

Market Forecast

OLED Lighting Market Forecast

- OLED lighting will pick up in 2011, and reach \$6.3B by 2018.
- The OLED lighting market will reach \$1.5B by 2015, and \$6.3B by 2018.
- Large investments have been made in OLED lighting in the EU, US, Japan and Korea.
- There are about 20 OLED lighting organizations worldwide. Europe is currently the leading participant in OLED lighting in terms of projects numbers, government funding, and participating companies.
- Over 100 companies and universities are currently working on OLED lighting.

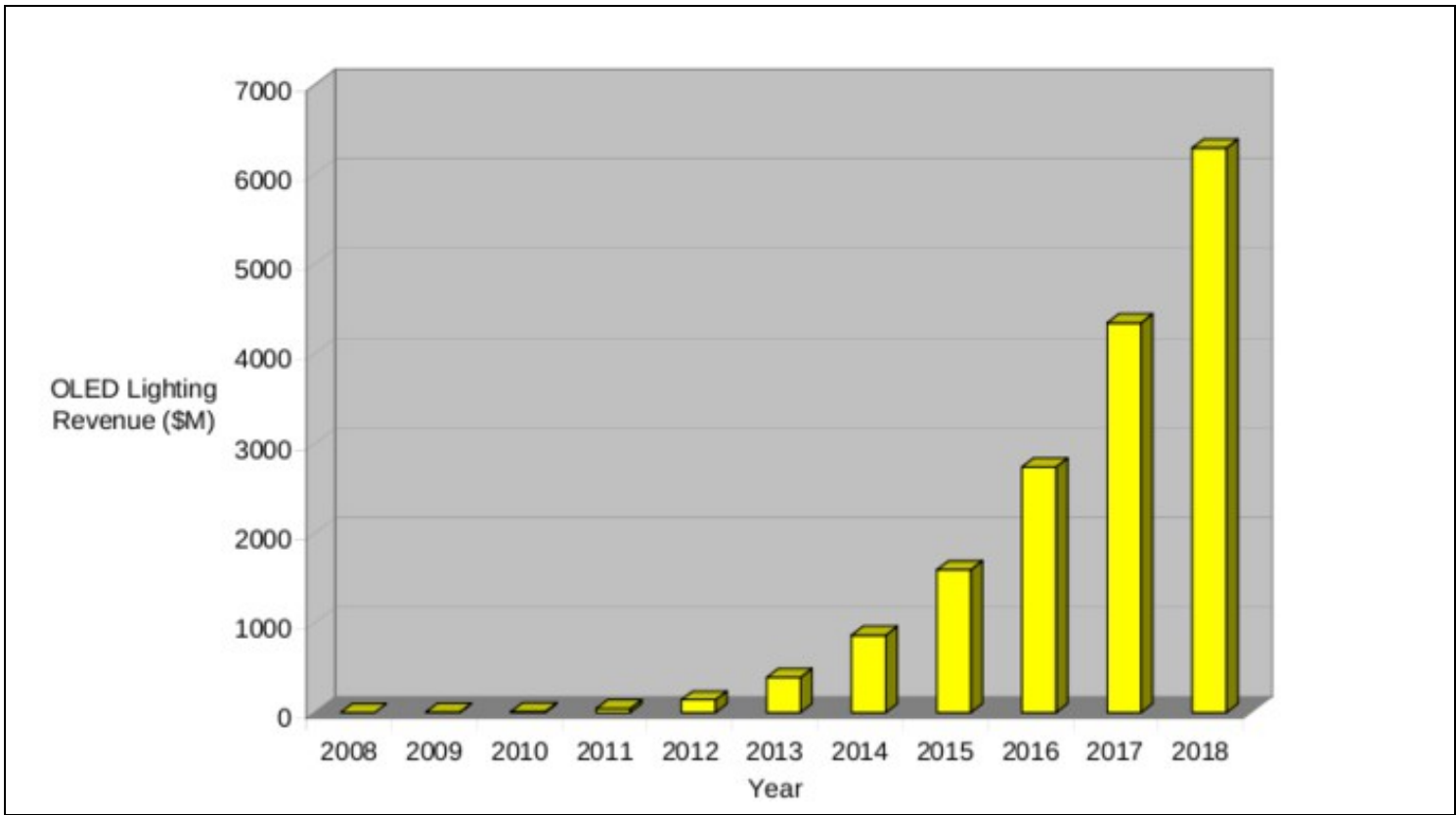

OLED Lighting Market Forecast
OLED TV Market Forecast

- OLED TV sets will account for around half of all revenue for OLED panels in 2012, growing rapidly from just \$150 million in 2011 to \$1.5 billion in 2013.
- iSuppli's similarly forecasts the global OLED TV market will reach 2.8 million units by 2013, managing a compound annual growth rate (CAGR) of 212.3% from just 3,000 units in 2007.
- In terms of global revenue, OLED TV will hit \$1.4 billion by 2013, increasing at a CAGR of 206.8% from \$2 million in 2007.

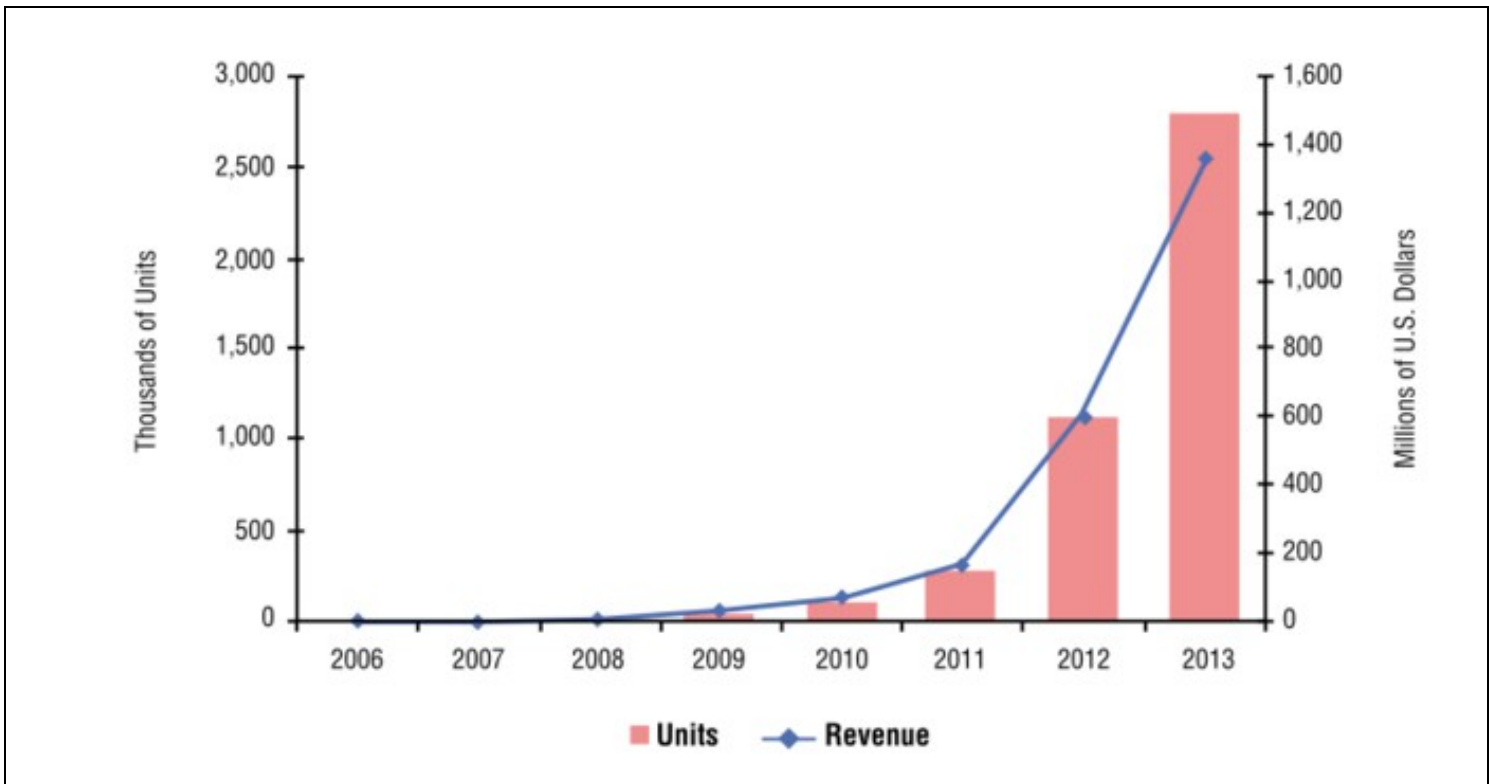

OLED TV Market Forecast
OLED Display Market Forecast

- OLED display market will grow to \$5.5 billion by 2015, from \$0.6 billion in 2008, with a CAGR of 37%. Currently, this growth is being driven by the adoption of active matrix OLED (AMOLED) displays for the primary display in mobile phones and portable media players.

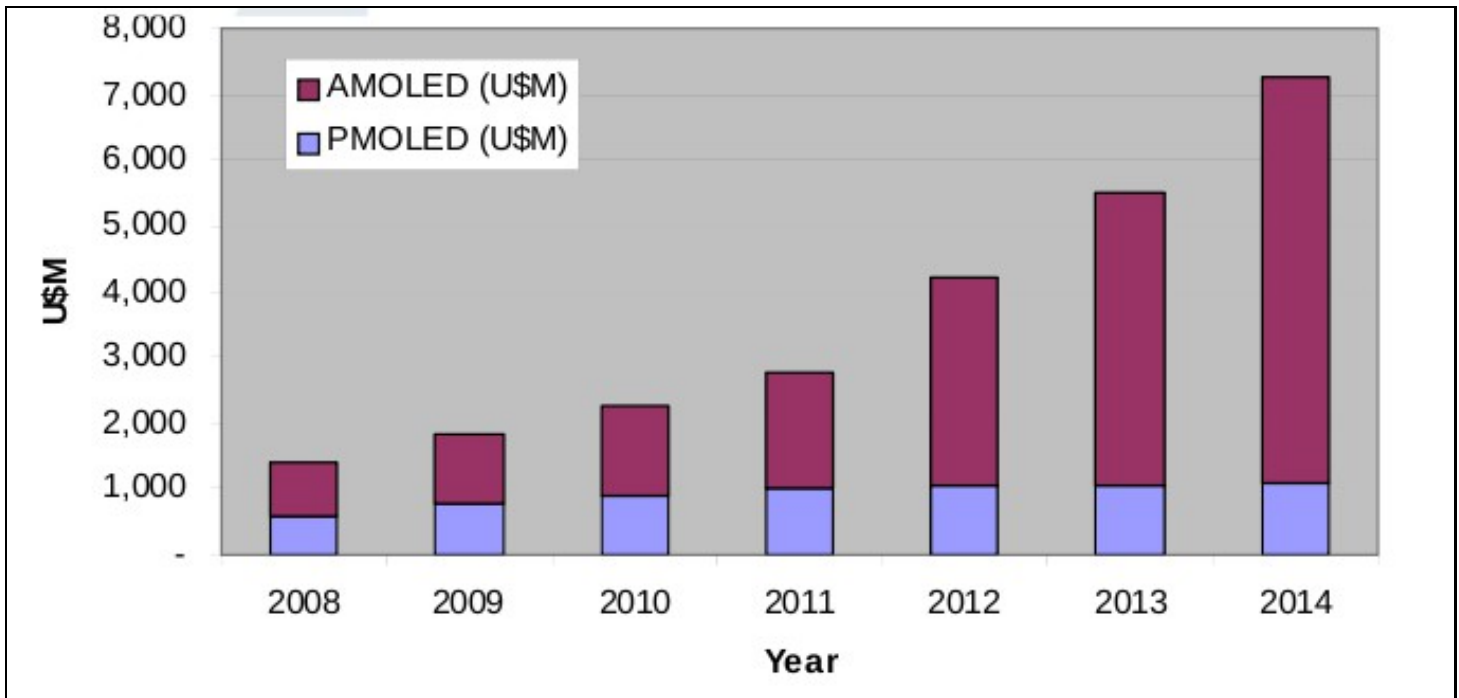

OLED Display Market Forecast

Recent Licensing Activities in OLED Segment

Licenser	Licensee	Date	Details
Global OLED Technology LLC	OLEDWorks	6th Dec 2011	Under the terms of the royalty-bearing license, OLEDWorks is granted the right to use certain GOT patents in connection with OLEDWorks' commercialization of specified OLED lighting-related products.
Universal Display	Moser Baer	8th Feb 2011	Moser Baer agreed to license Universal's OLED technology and purchase UniversalPHOLED (phosphorescent OLED) materials for white OLED panel manufacturing. The companies have agreed to work together for five years in the development of Moser Baer's US-based OLED panel manufacturing project.
Universal Display	Pioneer Corp	29th Sep 2011	Pioneer is supposed to use Universal Display's highly efficient, high-performance UniversalPHOLED® technology and materials for the manufacture and sale of OLED lighting products
DuPont	Samsung	3rd Nov 2011	Samsung needed new technology for its larger models for televisions and hoped to benefit from DuPont's recent innovations.

Landscape Analysis Of Top-Emission OLED

Competitor Landscape

Top Assignee

Top Assignee

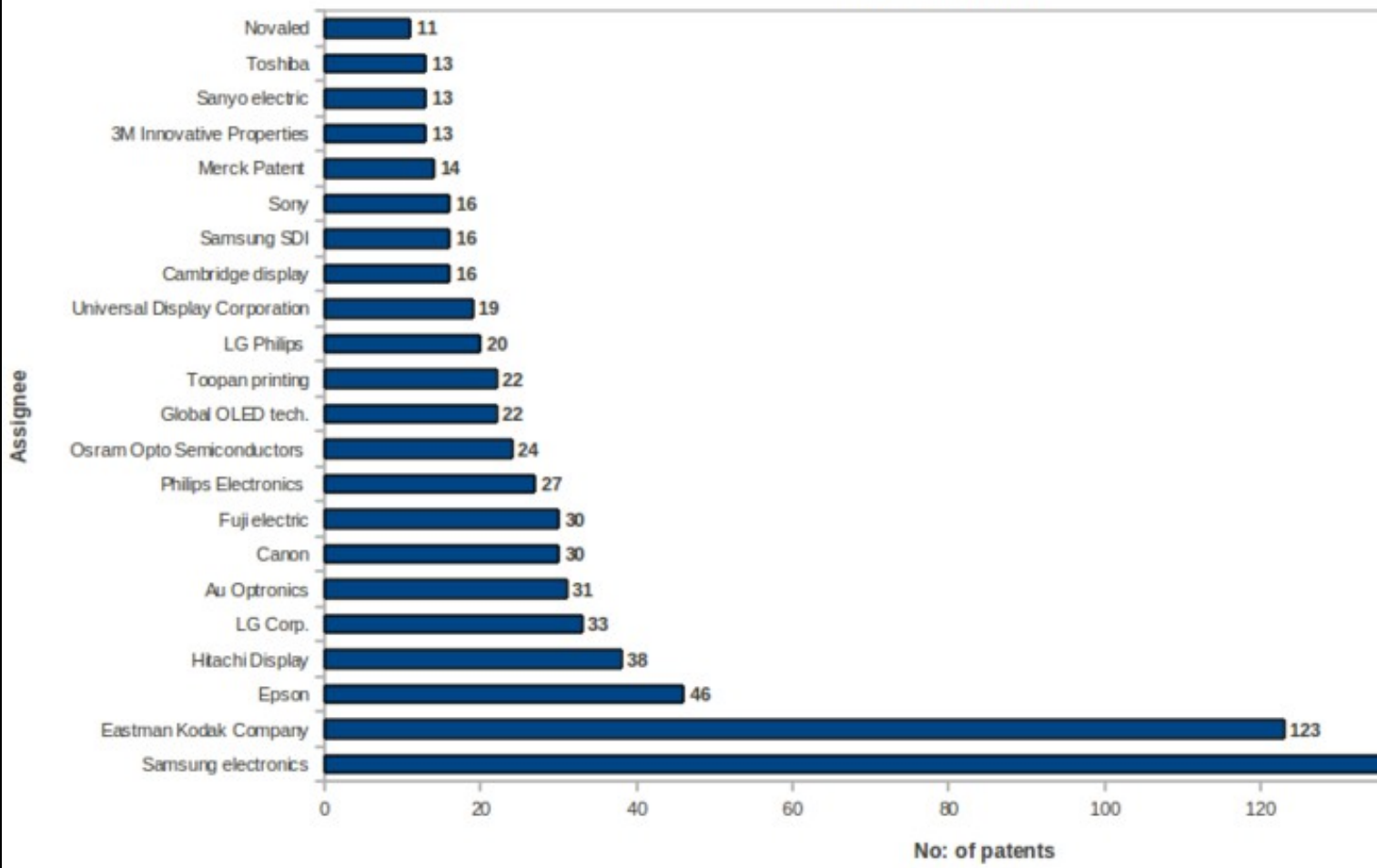

Top Assignee
Filing trends over the publication years

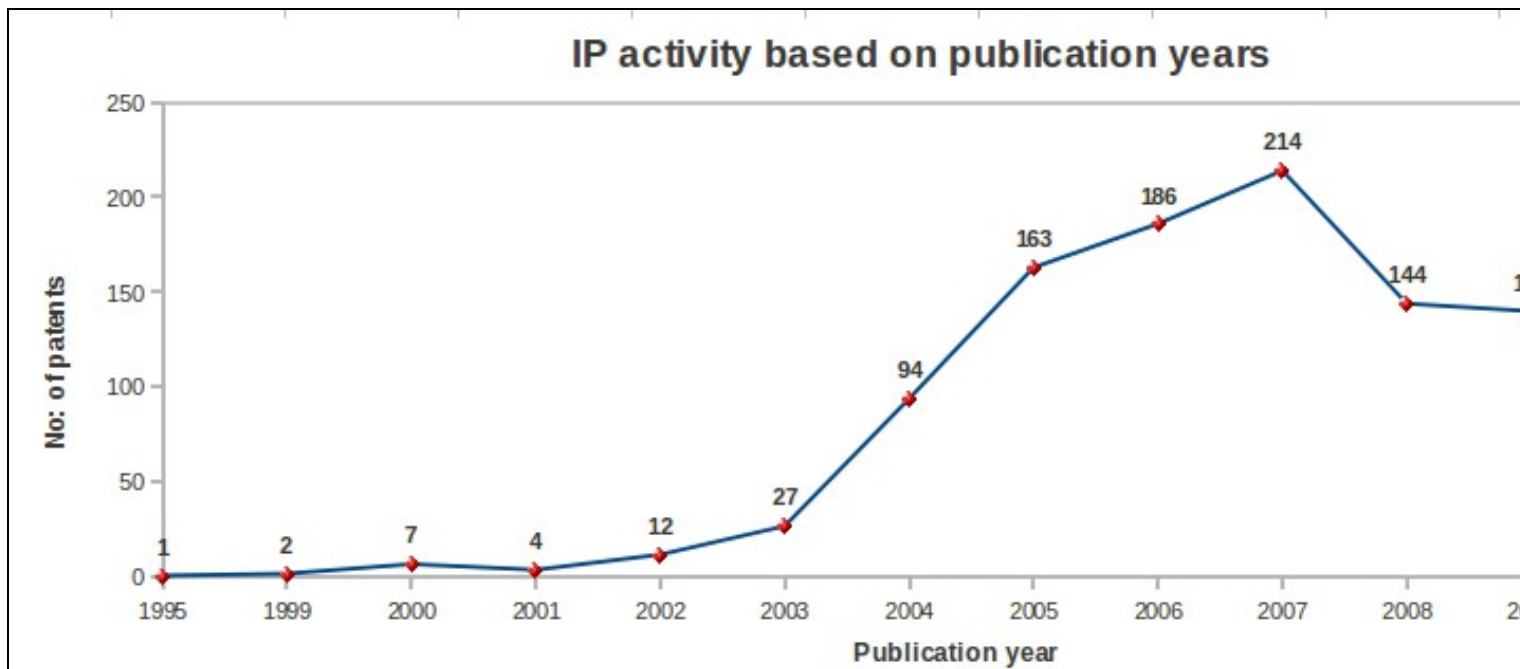

IP activity based on publication years

Filing trends over the priority years

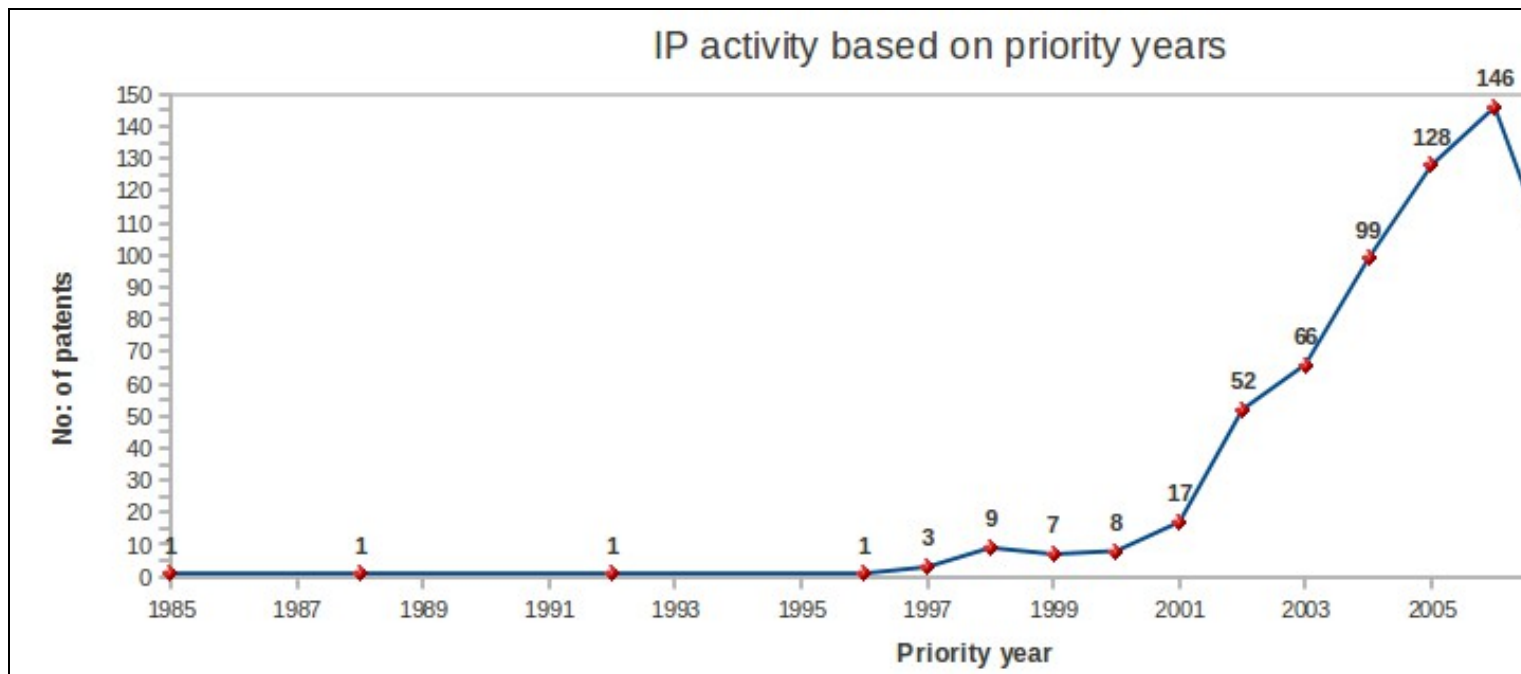

IP activity based on priority years

Geographical Distribution based on family members

- The geographical distribution is based on 10 sample patent numbers along with all their family members.

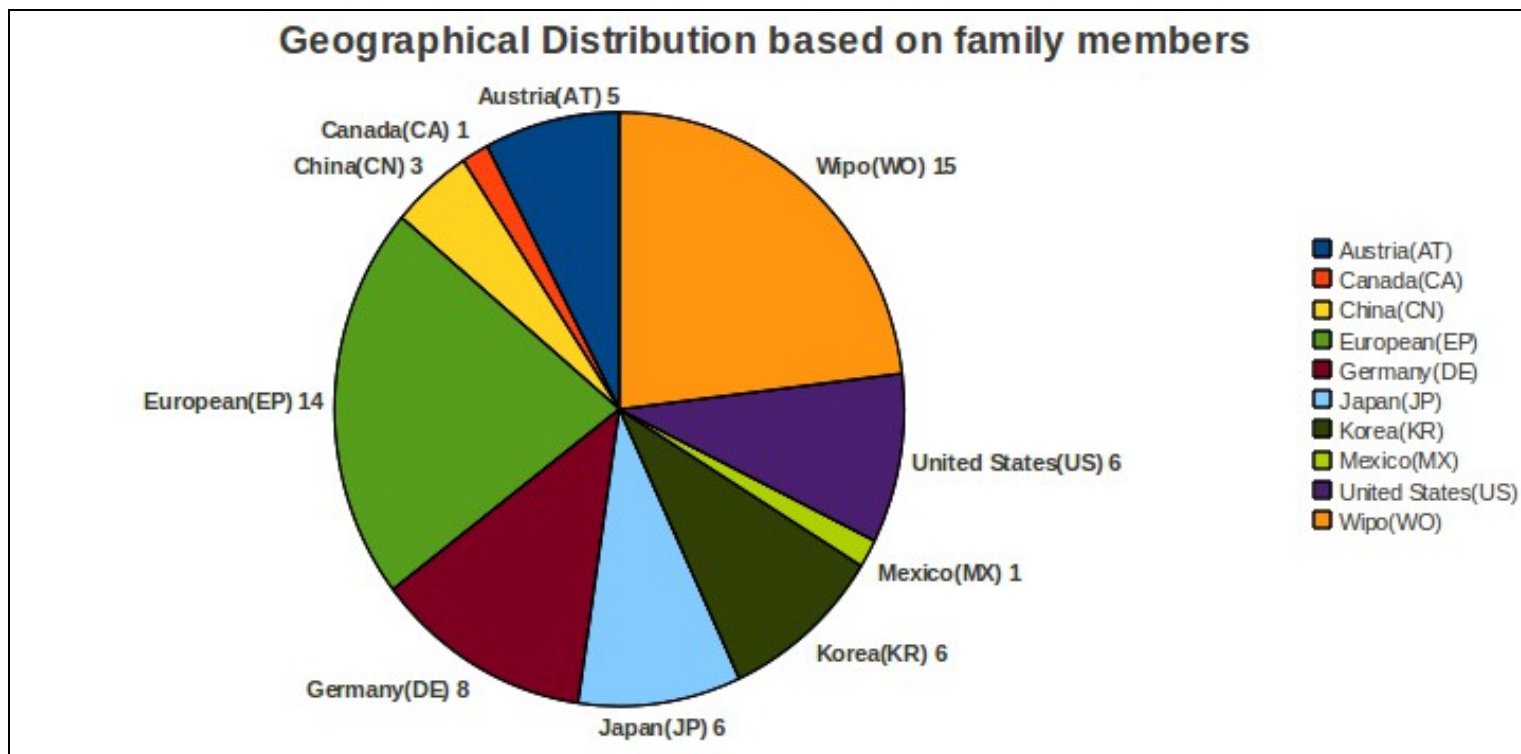

Geographical Distribution based on Family members of OLED

Key Inventor Mapping

S.No	Inventor	2000	2001	2002	2003	2004	2005	2006	2007	2008	2009	2010	Total Result
1	Cok, Ronald			1	3	22	18	17	14	15	4	2	96
2	Park, Jin Woo								18	2			20

3	Choi, Beohm Rock						1	6	7	2						16
4	Kim, Nam Deog							7	6	3						16
5	Tyan, Yuan Sheng						2	7	3	1	1	1				15
6	Winters, Dustin						2	5	5	2	1					15
7	Choi, Dong Soo									13	1					14
8	Choi, Joon Hoo						2	3	4	5						14
9	Kwak, Won Kyu						1	1	9	1	1	1				14
10	Miller, Michael						4	4	2	1	1	1	1			14
11	Park, Jae Yong					2	8	4								14
12	Shore, Joel						2	2	5	3	1	1				14
13	Arnold, Andrew						4	5	1	1	1	1				13
14	Boroson, Michael					1		4	3	1			4			13
15	Goh, Joon Chul						1	4	5	3						13
16	Tanaka, Masahiro						1	1	1	5	4	1				13
17	Choong, Vi En						5	5	2							12
18	Ghosh, Amalkumar	2	1				1	3	5							12
19	Kim, Eun Ah							1	2				9			12
20	Kobayashi Hidekazu							1	2	2	5	1	1			12
21	Total Result	2	1	1	6	45	67	72	90	47	18	15	362			

Most Cited Patents

S.No	Publication Number	Assignee/Applicant	Title	Publication Date	Count of Citing Patents
1	US6069443A	Fed Corporation	Passive matrix OLED display	30/05/2000	97
2	US6366017B1	Agilent Technologies	Organic light emitting diodes with distributed bragg reflector	02/04/2002	80
3	US20020197511A1	United Of America As Respresented By The Secretary Of The Air Force	High efficiency multi-color electro-phosphorescent OLEDs	26/12/2002	51
4	US6265820B1	Emagin Corporation,De	Heat removal system for use in organic light emitting diode displays having high brightness	24/07/2001	50
5	US20020195968A1	IBM	Oled current drive pixel circuit	26/12/2002	44
6	US20020186209A1	Eastman Kodak Company	Touch screen for use with an OLED display	12/12/2002	42
7	US20030127973A1	Universal Display Corporation	OLEDs having increased external electroluminescence quantum efficiencies	10/07/2003	41
8	US6844673B1	Alien Technology Corporation	Split-fabrication for light emitting display structures	18/01/2005	38
9	US20040174116A1	Universal Display Corporation	Transparent electrodes	09/09/2004	36
10	US20050194896A1	Hitachi Displays Ltd.	Light emitting element and display device and illumination device using the light emitting element	08/09/2005	35
11	US20020074935A1	Universal Display Corporation	Highly stable and efficient OLEDs with a phosphorescent-doped mixed layer architecture	20/06/2002	35
12	US20040217702A1	Corning Incorporated	Light extraction designs for organic light emitting diodes	04/11/2004	33
13	US20020030647A1	Universal Display Corporation	Uniform active matrix oled displays	14/03/2002	32
14	US20050248270A1	Eastman Kodak Company	Encapsulating OLED devices	10/11/2005	31

15	US20040113875A1	Eastman Kodak Company	Color oled display with improved power efficiency	17/06/2004	29
16	US20030230972A1	Eastman Kodak Company	Oled display having color filters for improving contrast	18/12/2003	28
17	US20050040756A1	Eastman Kodak Company	OLED device having microcavity gamut subpixels and a within gamut subpixel	24/02/2005	27
18	US6670772B1	Eastman Kodak Company	Organic light emitting diode display with surface plasmon outcoupling	30/12/2003	26
19	US20040061136A1	Eastman Kodak Company	Organic light-emitting device having enhanced light extraction efficiency	01/04/2004	26

Most Cited Patents Mapping

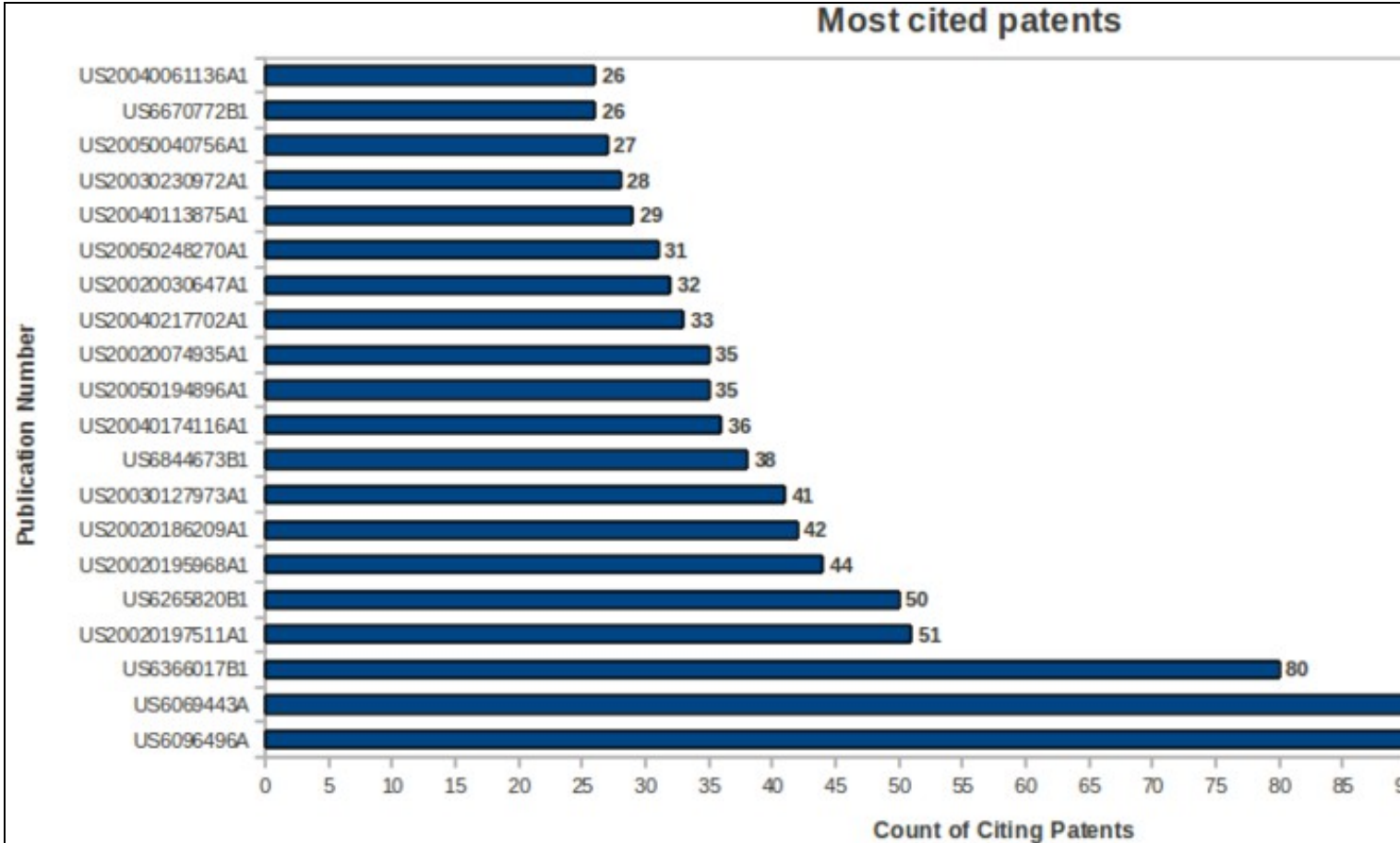

Most Cited Patents

Technology Mapping

- In OLED devices not all internally generated light is coupled out of the device (only 20%-50%), which reduces the device efficiency and lifetime.
- Modification in structures are applied to improve outcouple efficiency in order to enhance the efficiency and lifetime of top emission OLEDs.
- Below is a snapshot of how various organizations are using different design structures, using the same principle of internal reflection, to achieve higher out-coupling efficiencies.

Comparison of out coupling of waveguiding light in top-emission polyLED stack

WO0215292

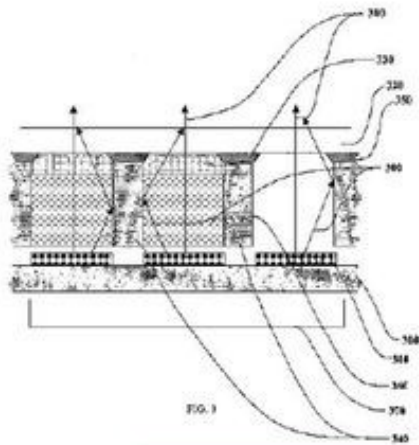

Short summary: The OLED stack emits light upon activation of the cathode line and anode line (not shown) to which it is connected. The anode may be a bottom electrode or a top electrode. The cathode may be a top electrode or a bottom electrode.

- 300 - Bottom substrate
- 310 - OLED stacks
- 320 - Top substrate
- 330 - Color filters
- 340 - Color changing material
- 350 - Black matrix material
- 360 - Barrier structure
- 370 - Pixel
- 380 - Light

Inventive step: Some light is emitted from the OLED stack at undesirable angles (stray light), hits the barrier material and is reflected so that it passes through the CCM (Color changing material) and the color filter and emerges through the top substrate. The high reflectivity of the barrier material allows the rays of light that strike the barrier at an angle to emerge from the display structure towards the viewer, thus, reducing light loss and increasing viewing angle.

- Some light is reflected out of the OLED at stray angles in typical cases. By using a barrier material (form of microparticles) in the cathode layer, this light at stray angles hits the barrier material, and some of it is reflected back and guided out at the right angles, reducing light loss.

US20030127973

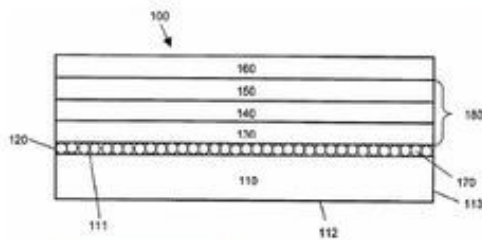

- 100 - OLED device
- 110 - Substrate
- 111 - Top surface
- 112 - Bottom surface
- 113 - Side surface
- 120 - Polymeric layer
- 130 - Anode layer
- 140 - Light-emitting layer
- 150 - Cathode layer
- 160 - Cover region
- 170 - Microparticles

Short summary: Microparticles increase the out-coupling efficiency of light generated within a light-emitting layer by scattering light generated from the light-emitting layer and, decreasing the propensity for the light to be confined within any portion or distinct layer of the device due to internal reflections and being absorbed within the device or transmitted out of the edges of the device. The Microparticles may act as miniature lenses that preferentially direct the generated light out of and normal to a surface of the device.

Inventive step: Polymeric layer having microparticle incorporated is disposed over the substrate. Microparticle are from transparent inorganic or polymeric material of irregular or regular shaped particles (microsphere).

- Microparticles are incorporated in the substrate, which prevents light loss by reflecting light emitted at stray angles.

US20050045873

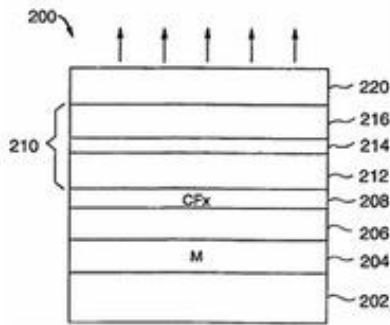

Short summary: The generated light is reflected at the mirror-like surface of the anode and transmitted through the cathode.

- 200 - Organic electroluminescent device
- 202 - Substrate
- 204 - Anode
- 206 - Nonmetal layer
- 208 - Polymer layer
- 210 - Organic light-emitting structure
- 212 - Organic hole-transporting layer
- 214 - Organic light-emitting layer
- 216 - Organic electron-transporting layer
- 220 - Cathode

Inventive step: The anode comprises a layer of conductive and highly reflective material (Al or Ag), so as to provide a mirror-like surface. A nonmetal layer (ITO, NiO.sub.x.) comprising substantially an oxide is formed on the anode.



- A highly reflective anode is provided made of Aluminium or Silver, with a mirror like finish, to reflect light.

US6943372

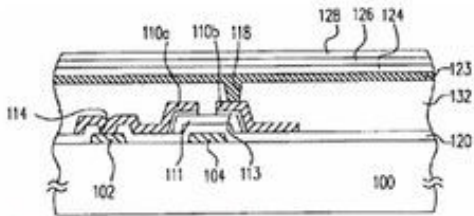

- 100 - Substrate
- 102 - Metal line
- 104 - Gate
- 111 - Channel layers
- 113 - Contact layer
- 114 - Opening
- 118 - Opening
- 120 - Dielectric layer
- 123 - Shielding layer
- 124 - Anode layer
- 126 - Organic light-emitting layer
- 128 - Transparent cathode layer
- 132 - Passivation layer
- 110b - Source terminals
- 110c - Drain terminals

Short summary: When electrons and holes from the anode layer and the transparent cathode layer are combined inside the organic light-emitting layer, light emission mechanism is triggered to produce light. Because the transparent cathode layer is made from a transparent material, light produced by the organic light-emitting layer will emit from the top section of the device. Since the shielding layer is able to reflect or absorb light, light is prevented from passing out through the bottom section of the device.

Inventive steps: The shielding layer formed under anode layer is fabricated using a conductive material with reflective property including aluminum, chromium or molybdenum. The anode layer and the shielding layer have an identical pattern. The shielding layer is positioned over the substrate covering the passivation layer (planar dielectric material layer). The presence of a shielding layer also permits the anode layer to extend, along with the shielding layer, into the top portion of the thin film transistor, thereby leading to an increase in the overall light-emitting area of each pixel structure.



- A shielding layer is provided below the anode, across its entire surface, thus increasing the surface area from which light can be reflected outside.

US20040080476

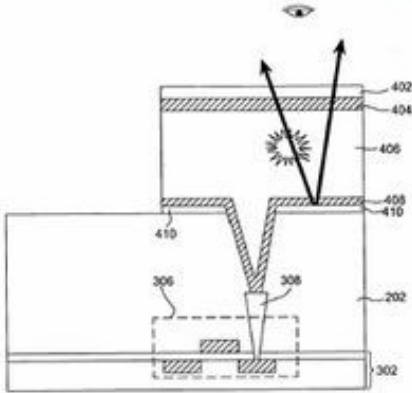

Organic layer emit radiation in all directions, reflecting layer disposed under the anode and reflects the radiation toward the transparent second electrode (Cathode).

- 202 - Planarization layer
- 302 - Substrate
- 306 - Switch
- 308 - Connection unit
- 402 - Cap layer
- 404 - Transparent second electrode
- 405 - Organic layer
- 408 - First electrode anode
- 410 - Reflective layer

Inventive steps: The reflective layer is made of material with high reflectance, such as silver, aluminum or alloy.



- The reflective layer, anode, is made of a highly reflective surface like Aluminium alloy or silver.

Conclusion

The innovation is towards:

- Incorporating micro-particles structure over the substrate that provide a reflective surface.
- Highly reflective materials using metals like Molybdenum etc.

Like this report?

This is only a sample report with brief analysis
Dolcera can provide a comprehensive report customized to your needs

Buy the customized report from Dolcera		
Patent Analytics Services	Market Research Services	Purchase Patent Dashboard
Patent Landscape Services	Dolcera Processes	Industry Focus
Patent Search Services	Patent Alerting Services	Dolcera Tools

Contact Dolcera

Samir Raiyani
Email: info@dolcera.com
Phone: +1-650-269-7952